

MEGALINEAR



MEGADYNE

Introduction to open-end belts	2	RPP14XHP	66
Classifications	4	STD5	68
Technical calculation	6	STD8	70
Linear motion calculation example	8	HG	72
Conveyor belt calculation example	9	TG5	74
Calculation parameters	10	TG10	76
Belt installation	12	TG20	78
Belt data		ATG5	80
MXL	14	ATG10	82
XL	16	ATG20	84
L	18	QST5	86
H	20	QST8	88
XH	24	QST14	90
T2,5	26	GW14	92
T5	28	GW20	94
TT5	32	FLAT	96
T10	34	FC T5	98
T20	40	FC T10	99
AT3	42	Fixing plates	100
AT5	44	Positioning and transmission precision	103
AT10	46	Cleats	104
AT20	50	Cover properties	118
MTD3	52	Special execution feasibility	120
MTD5	54	Antistatic polyurethane timing belts	121
MTD8	56	Special execution photos	122
MTD14	58	Data sheet	124
RPP5	60		
RPP8	62		
RPP14	64		

INTRODUCTION TO OPEN-END BELTS

Megadyne started manufacturing moulded transmission belts in 1957 and extruding open ended belts in 1975. Megalineer open length belts are manufactured in thermoplastic polyurethane, that gives superior wear and abrasion resistance. Various types of steel cord, offer good running characteristics, even under high tractive loads. Advanced production processes, allow the ability to engineer bespoke technical design solutions to meet market demands. By selecting from a range of components and materials, Megalineer belts can be manufactured to perform in even the most demanding applications. **MEGALINEAR** open-end belts are particularly suited where the most precise accuracy of position, low noise and long maintenance free cycles are the key requirements. Megadyne has expanded the Megalineer range to include:

- **MEGALINEAR QST**
- **MEGALINEAR GW**
- **MEGALINEAR FC**

Uniquely designed to reduce the noise levels, generated during high speed operations, **MEGALINEAR QST** is completely self-tracking without the need for flanged pulleys. The nylon faced helical offset teeth design, provides a high torque capacity.

For heavier applications, Megadyne have introduced the **MEGALINEAR GW**, a high performance thermoplastic polyurethane belt. Superior load capacities can be achieved due to the high shear strength of the tooth design, coupled with high tension, steel zinc coated cords, **MEGALINEAR GW** guarantees a greater transmittable power under continuous high loads.

MEGALINEAR FC is a new range of belts of the **MEGALINEAR** family. Specifically introduced for the food processing industry, **MEGALINEAR FC** is manufactured with food contact approved materials, according to European regulations EU 1935/2004, EU 10/2011 and EU 174/2015. Manufactured in T5/T10 pitch without nose gap between the teeth and available with a variety of backing profiles, for all kinds of conveying and processing applications. These advanced FDA synchronous belts, have excellent resistance to chemicals and corrosion, certified for wet and dry food contact. Their use is particularly prevalent in a variety of applications in food processing and packaging. The homogenous belt design ensures a significantly greater service life, with a high level of hygienic integrity.

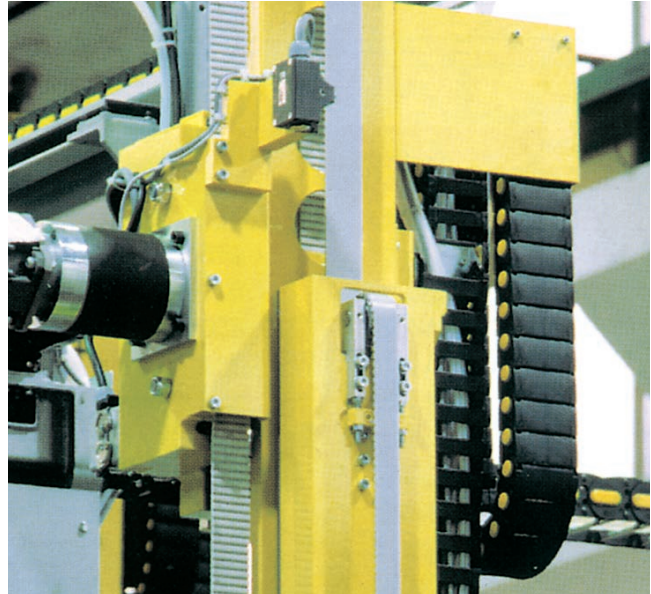

INTRODUCTION TO OPEN-END BELTS

Thanks to their features, Megalineer belts can be successfully used in a wide range of application such as:

- conveyors
- automatic sliding doors and garage opening system
- elevators
- automated handling devices
- linear drivers
- positioning system
- wood industry
- textile machine
- serigraphic industry
- glass industry
- stone and marble industry
- packaging industry
- robot systems
- tobacco industry
- paper and carton industry
- chemist and pharmaceutical industry

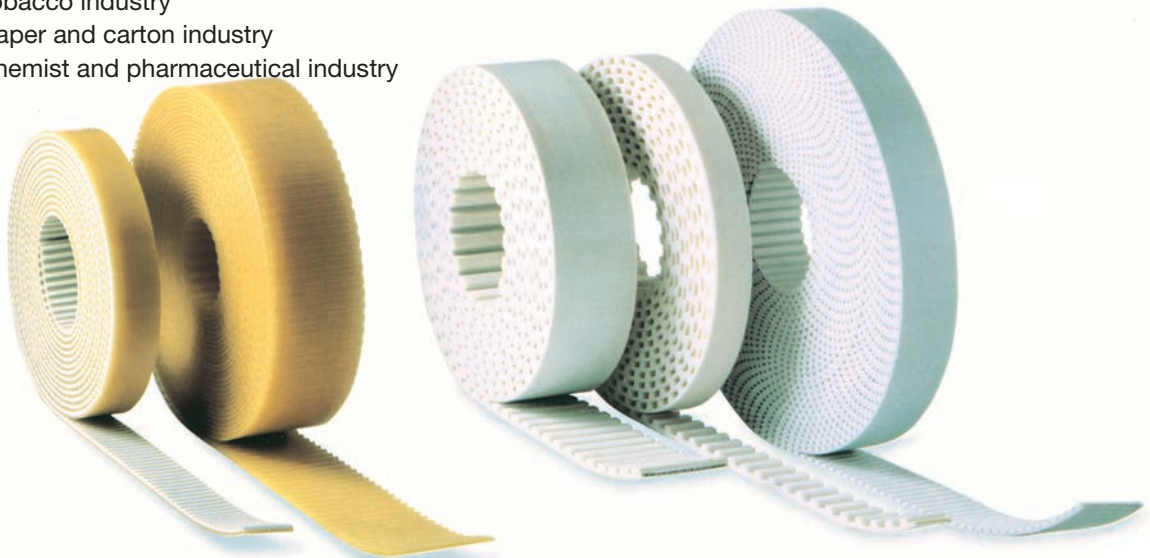
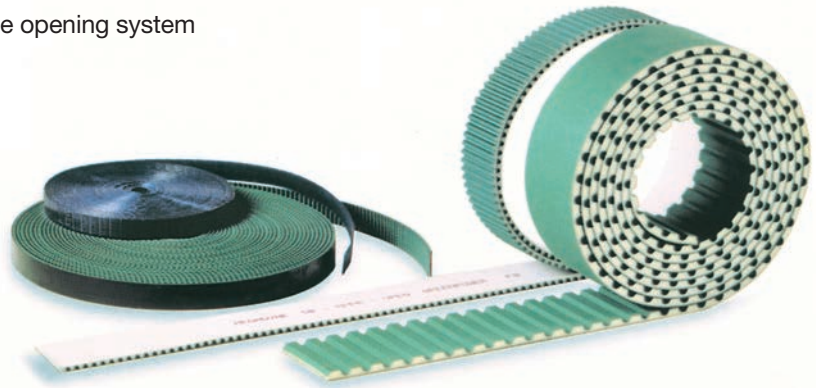

Megadyne has developed a very wide range of solutions with numerous tooth designs, tensile members and compound, suitable for all applications.

STANDARD RANGE



MXL • XL • L • H • XH



T2,5 • T5* • TT5 • T10* • T20



AT3 • AT5 • AT10 • AT20



MTD3 • MTD5 • MTD8 • MTD14



RPP5 • RPP8 • RPP14 • RPP14XHP



STD5 • STD8



HG • TG5 • TG10K6 • TG10K13 • TG20 • ATG5 • ATG10 • ATG20

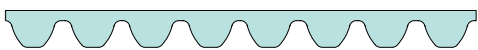

QST5 • QST8 • QST14



GW14 • GW20



P1 • P2 • P3 • P4

* Available in Food Contact version.

CLASSIFICATIONS

CLASSIFICATIONS

Megalinear Timing Belts are manufactured in thermoplastic polyurethane, with single parallel steel cords. This type of belts, developed by our Research & Development, offers good running characteristics and high traction loads. They are especially suited for power transmission and conveying with high loads and speeds. The addition of a nylon coating on the teeth during production enhances the running properties for specific applications and reduces the noise due to a lower frictional coefficient. An extra thickness of special coating is also possible on the back of the belt offering extra protection against aggressive or heavy products.

1. The body of the belts is white thermoplastic polyurethane 92 ShA, characterized by high levels of wear resistance even in the presence of shock and surge loading.
2. High strength S and Z parallel zinked steel tension members allow high breaking load and extremely low elongation. The combination of these high grade materials improves belt performances which can be summarised as follows:
 - exceptional resistance to abrasion and tooth shear
 - low coefficient of friction
 - high flexibility
 - ozone and temperature resistance (-25 °C / +80 °C)
 - oil, grease and gasoline resistance

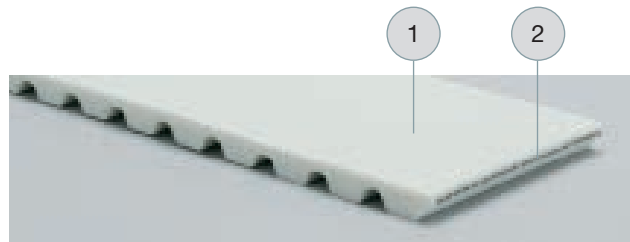

MECHANICAL AND CHEMICAL CHARACTERISTICS

- Constant dimensions
- Noiseless
- Free maintenance
- High flexibility
- High resistance steel traction cords, with little stretching and top flexibility
- Linear speeds up to 20 m/s
- Low pretension
- Constant length
- High abrasion resistance
- Ageing, Hydrolysis, Ozone resistant
- Working temperature -25 °C / +80 °C
- High resistance to Oils, Greases and Gasoline
- Fairly Acid-proof and Alkali-proof

BODY

Megalinear belts are manufactured with white thermoplastic Polyurethane 92 ShA as standard. Special compounds (different hardnesses, special properties) are available on request. Special compound and cords have to be tested and homologated on the application. Megadyne is not responsible for wrong functioning of special products. Here under some PU characteristics:

- | | |
|-----------------|--|
| Water | No problem in normal or sea clean water, at room temperature.
Over 60 °C there is a fast decrement of breaking strength. |
| Acids | In acid diluted proportions, at room temperature, this PU is moderately attacked.
In high concentration acid solutions, this PU has a very short lifespan.
Over 50 °C, acids are always dangerous for Thermoplastic PU. |
| Alkalis | In alkalis diluted proportions, at room temperature, this PU is moderately attacked.
In high concentration alkaline solutions, this PU has a very short lifespan.
Over 50 °C, alkalis are always dangerous for Thermoplastic PU. |
| Solvents | Thermoplastic PU is insoluble in the greater part of solvents.
Only the very polar solvents (same as tetrahydrofuran, dimethylformamide, n-methylpyrrolidone) can dissolve or tight damage PU.
The Esters or the Ketons (same as ethyl acetate or methylethylketene) can usually produce a bulge, decreasing mechanical characteristics.
The Hydrocarbons aromatic and the Hydrocarbons aliphatic produce very high bulge.
All the effects increase by increasing temperature. |
| Oils | PU has a high resistance to mineral pure oils (lubrificants, engine oils, combustible oils).
Usually, high performance syntetic oils, due to special additives contained, can be incompatible with Thermoplastic PU, especially at high temperature. |

Greases	PU has a high resistance to mineral pure greases (lubricants greases). Usually, high performance syntetic greases, due to special additives contained, can be incompatible with Thermoplastic PU, especially at high temperature.
Fuels	Good resistance to petrols without Alcohols. In presence of Alcohols, Thermoplastic PU can suffer deterioration. Fuels including Aromatiche stuffs can produce reversible bulges.
Microorganisms	In presence of grime, containing humidity, Microorganisms can develop. In case that Microbic attack can produce danger, you have to use a special kind of PU.
Weather agents	Good resistance to atmospheric agents. White colour can change to light yellow under long UV exposure. In any case this hasn't influence on mechanical resistance.

CORDS

Standard cord	Megalinear is manufactured with S and Z parallel zinked steel cords as standard.
Kevlar	Kevlar tension cords are suggested for: <ul style="list-style-type: none"> • Non magnetic, for use in drives with metal detectors • Widely used in the food industry • Applications in damp evonement must be avoided Kevlar cord belts have a lower dimentional stabiliy compared to stell cord belts. Length and tollerance may change.
HP	High Performance cords have 25% more strength capacity than standard cords. They are recommended for high repeatability applications.
HF	High Flexibility cords can accept smaller pulley and idler diameters than standard cords. They are suitable for multi-shaft drives with severe reverse bending.
HPF	High Performance and Flexibility cords have 25% more strength capacity like the HP cords, but they are more flexible than the HP cords. They are suggested for high performance and multi-shaft drives.
Stainless steel	Stainless steel cords have 25% less strength capacity than standard cords. They are recommended for water applications.

COATING

Megalinear can be manufactured with special coating on the teeth or on the back. Please check on page 118 and 119.

IDENTIFICATION CODE

Using the information in the table below, it is possible to identify the correct belt for every application. The code is composed of letters and numbers as the following example::

1	2	3	4	5	6					
J	+	50	+	AT	+	10	+	10000	+	SPECIAL MANUFACTURES

- 1) **J** joined belt.
- 2) **ML** Megalinear belt open-end.
- 3) **50** this number indicates the width of requested belt. The value is in mm for a belt with a pitch in mm, and in inches for a belt with a pitch in inches.
- 4) **AT** this code composed by letters indicates the selection of profile.
- 5) **10** this number indicates the standard pitch of the belt. It is expressed in mm.
- 6) **10000** the last number indicates the length of the belt always in mm regardless of pitch.
- 6) **SPECIAL MANUFACTURES:**
 - special cords as Kevlar or HP or HF or HPF or stainless steel
 - special compound as different hardness 85 ShA or different colours (black - red - yellow - blue)
 - extra coating NFT or NFB or AVAFC or Tenax or Linatex or Honey comb or PU black cellulose or PU yellow or Neoprene rubber.

TECHNICAL CALCULATION

LINEAR MOTION BELT

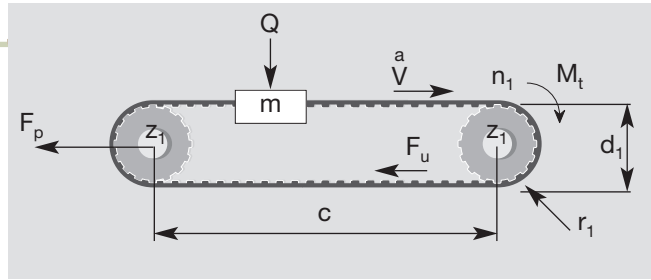

OMEGA LINEAR MOTION BELT

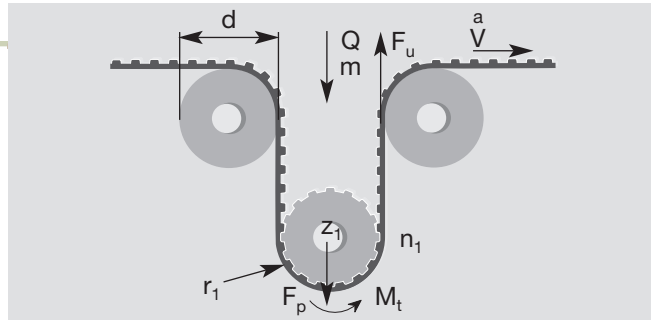

CONVEYOR BELT

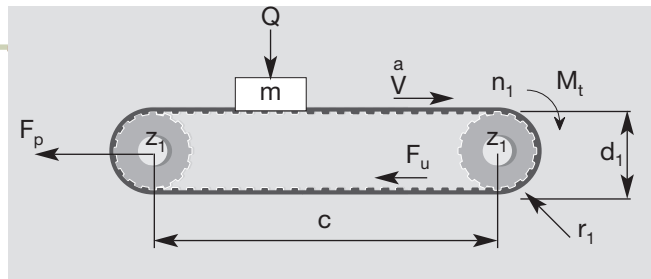

The following pages contain data, formulae and tables that are required to design a new belt drive. For critical and difficult drives, it is recommended that you contact our Application Department for advice.

Symbol	Unit	Definition	Symbol	Unit	Definition
a	m/s ²	acceleration	g	m/s ²	gravity (9,81)
b	mm	belt width	μ	–	friction coefficient
C	–	safety factor	m	Kg	conveyed mass
Δl/100	%	elongation	M_t	Nm	drive torque
d	mm	idler pitch diameters	n₁	1/min	revs/min (RPM) of drive sprocket 1
d₁	mm	sprocket pitch diameter	P	KW	drive power
F_p	N	pretension	Q	N	force exerted by mass (m)
F_u	N	peripheral force	V	m/s	belt speed
F_{p spec}	N/cm	transmittable force per tooth per unit width	Z₁		number of teeth of sprocket
MTL	N	max traction load	Z_m		number of teeth in mesh on driver sprocket (12)
BS	N	breaking strength	Z_L		number of teeth of large pulley
c	mm	centre distance	Z_s		number of teeth of small pulley
			p		belt pitch

Max traction load is maximum acceptable traction on cords.
 Breaking strength is necessary load to break belt cords.
 Elongation is belt elongation under load.

USEFUL FORMULAE AND CONVERSION FACTORS

$$V = \frac{d_1 \cdot n_1}{19100} \quad n_1 = \frac{V \cdot 19100}{d_1} \quad d_1 = \frac{V \cdot 19100}{n_1} \quad Q = m \cdot g$$

$$P = \frac{M_t \cdot n_1}{9550} \quad M_t = \frac{9550 \cdot P}{n_1} \quad M_t = \frac{F_u \cdot d_1}{2000}$$

CHOICE OF BELT PITCH AND SPROCKETS

For optimum belt pitch see tables on page 10.

For optimum choice of sprocket size, it is desirable to have as near to 12 teeth in mesh as possible.

Knowing mass	→ For horizontal & conveying drives	$F_u = (m \cdot a) + (m \cdot g \cdot \mu)$
	(Note: values of μ can be found in table 1 on page 11).	
	→ For vertical drives	$F_u = (m \cdot a) + (m \cdot g)$
Knowing drive torque		$F_u = 2000 M_t / d_1$
Knowing drive power		$F_u = 19.1 \cdot 10^6 \cdot P / (d_1 \cdot n_1)$

BELT WIDTH AND PROFILE ESTIMATION

The belt width b should be calculated using the following formula

$$b = (F_u \cdot c_s \cdot 10) / (F_{p \text{ spec}} \cdot Z_m)$$

C_s = safety factor from page 11 table 4
 F_u = from above calculation
 Z_m = number of teeth in mesh on driver sprocket
 $Z_m = [0,5 - \frac{4 \cdot p}{79 \cdot c} (Z_L - Z_s)] \cdot Z_s$
 = (if calculated $Z_m > 12$ for an open-end application use $Z_m = 12$)
 = (if calculated $Z_m > 6$ for a joined application use $Z_m = 6$)
 $F_{p \text{ spec}}$ = transmittable force per tooth per unit width (see table on belt data pages)

PRE-TENSIONING

The suggested installation tension:

$F_p = 2 \cdot F_u$ for linear and omega linear movement applications
 $F_p = F_u$ for conveyor applications

CORD CHECK

The maximum allowable tensile load of the belt pitch/width combination selected (see tables on belt data pages):

$$\text{max traction load of choosen belt} > \frac{F_p}{2} + (F_u \cdot C_s)$$

SPROCKET AND IDLER DIAMETER CHECK

Ensure that all selected pulley and idler diameters are equal to or greater than the minimum values specified in corresponding belt data page.

ELONGATION

When the belt is operating there will be an elongation proportional to max traction load:

$$\Delta l / l_0 = (F_u \cdot 4) / \text{max traction load}$$

LINEAR MOTION CALCULATION EXAMPLE (OPEN-END BELT)

MACHINE DATA

$C = 2.000 \text{ mm}$
 $d_1 = 76 \text{ mm}$
 $n_1 = 300 \text{ RPM}$
 $P = 1,8 \text{ KW}$
 low fluctuating load

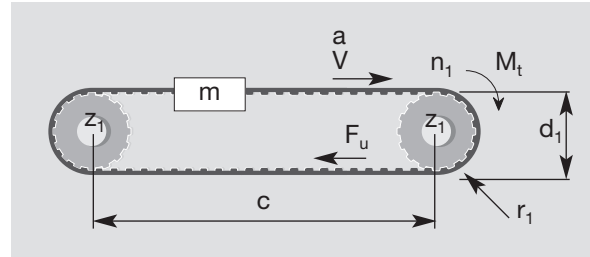

CHOICE OF BELT PITCH AND SPROCKETS

According to the belt pitch selection table n.1 on page 10 considering the values of P and n_1 , we select RPP8 belt. Then we consider the pulley diameter nearest to the requested value and the corresponding n . of teeth (see technical information on page 63). Therefore $Z_1 = 30$ teeth (with a pitch diameter of 76,4 mm).

CALCULATION OF THE EFFECTIVE TENSION

Since the drive power is known, F_u can be calculated

$$F_u = \frac{19,1 \cdot 10^6 \cdot P}{d_1 \cdot n_1} = \frac{19,1 \cdot 10^6 \cdot 1,8}{76,4 \cdot 300} = 1500 \text{ N}$$

DETERMINATION OF THE BELT WIDTH

$$b = \frac{F_u \cdot C_s \cdot 10}{F_{p \text{ spec}} \cdot Z_m}$$

$$b = \frac{1500 \cdot 1,4 \cdot 10}{62 \cdot 12} = 28,2 \text{ mm}$$

F_u = from before (1500 N)
 C_s = from page 11 table 4, for low fluctuating load $C_s = 1,4$
 Z_m = given that driver pulley has 30 teeth and n . of teeth in mesh = 15 but max Z_m is 12, then $Z_m = 12$
 n_1 = 300 RPM (given)
 $F_{p \text{ spec}}$ = 62N / cm (refer page 62 at 300 RPM)

Since the next closest width is 30 mm: 30 RPP8 is chosen.

PRE-TENSIONING

$$F_p = 2 \cdot F_u \quad F_p = 3000 \text{ N}$$

CORD CHECK

From page 62, RPP8 pitch 30 mm wide: max traction load 4750 N

$$\text{max traction load} > \frac{F_p}{2} + (F_u \cdot C_s) \quad \frac{F_p}{2} + (F_u \cdot C_s) = 1500 + 1500 \cdot 1,4$$

4750 N > 3600 N selected belt is acceptable.

SPROCKET AND IDLER DIAMETER CHECK

Ensure that all selected pulley and idler diameters are greater than or equal the minimum values specified on page 63.

ELONGATION

$$\Delta l_{/00} = \frac{F_u \cdot 4}{\text{max traction load}} = \frac{1500 \cdot 4}{4750} = 1,26 \text{ mm/m}$$

In the dynamic situations you will have an elongation of 1,26 mm per meter of operating belt.

CONVEYOR BELT CALCULATION EXAMPLE (JOINED BELT)

MACHINE DATA

$C = 5.000 \text{ mm}$
 $d_1 = 100 \text{ mm}$
 $V = 0,5 \text{ m/s}$
 $a = 0,5 \text{ m/s}^2$
 Guide in nylon
 $Q = 4500 \text{ N}$
 low fluctuating load

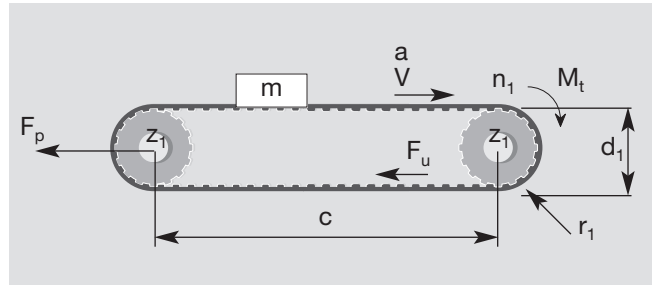

CALCULATION OF THE EFFECTIVE TENSION

Since the mass is known, F_u can be calculated $F_u = (m \cdot a) + (m \cdot g \cdot \mu)$ value of μ according to table 3 on page 11 = 0,35
 $F_u = (460 \cdot 0,5) + (460 \cdot 9,81 \cdot 0,35) = 1810 \text{ N}$
 $m = Q/g = 4500 / 9,81 = 460 \text{ kg}$

CHOICE OF BELT PITCH AND SPROCKETS

According to the belt selection table n. 2 on page 10, considering the values of F_u (for joined belts enter double of calculated F_u in table 2), we select T 10. Then we consider the pulley diameter nearest to the requested value and the corresponding n. of teeth (see technical information page 35). Therefore $Z_1 = 32$ teeth (with a pitch diameter of 101,86 mm).

DETERMINATION OF THE BELT WIDTH

$b = \frac{F_u \cdot C_s \cdot 10}{F_{p \text{ spec}} \cdot Z_m}$ $b = \frac{1810 \cdot 1,4 \cdot 10}{45 \cdot 6} = 93,85 \text{ mm}$	F_u = from before (1810 N) C_s = from page 11 table 4, for low fluctuating load $C_s = 1,4$ Z_m = given that driver pulley has 32 teeth and n. of teeth in mesh = 16 but max Z_m for joined belt is 6, hence, $Z_m = 6$ $n_1 = (Vp \cdot 60.000) / (\pi \cdot d_1) = (0,5 \cdot 60.000) / (\pi \cdot 101,86)$ as $d_1 = 101,86$ from before = 94 RPM $F_{p \text{ spec}} = 45 \text{ N / cm}$ (refer page 34, at 100 RPM)
---	---

Since the next closest width is 100 mm: 100 T10 is chosen.

PRE-TENSIONING

$$F_p = F_u \text{ so } F_p = 1810 \text{ N}$$

CORD CHECK

From page 34, T10 pitch 100 mm wide joined: max traction load 5415 N

$$\text{max traction load} > F_p + (F_u \cdot C_s) \quad F_p + (F_u \cdot C_s) = 1810 + (1810 \cdot 1,4)$$

5415 N > 4344 N selected belt is acceptable.

SPROCKET AND IDLER DIAMETER CHECK

Checking technical data on page 35 for pulley and idlers, it can be seen that the drive has acceptable pulley diameters.

ELONGATION

$$\Delta l / l_0 = \frac{F_u \cdot 4}{\text{max traction load}} = \frac{1810 \cdot 4}{5415} = 1,33 \text{ mm/m}$$

In the dynamic situations you will have an elongation of 1,33 mm per meter of operating belt.

CALCULATION PARAMETERS

BELT PITCH SELECTION

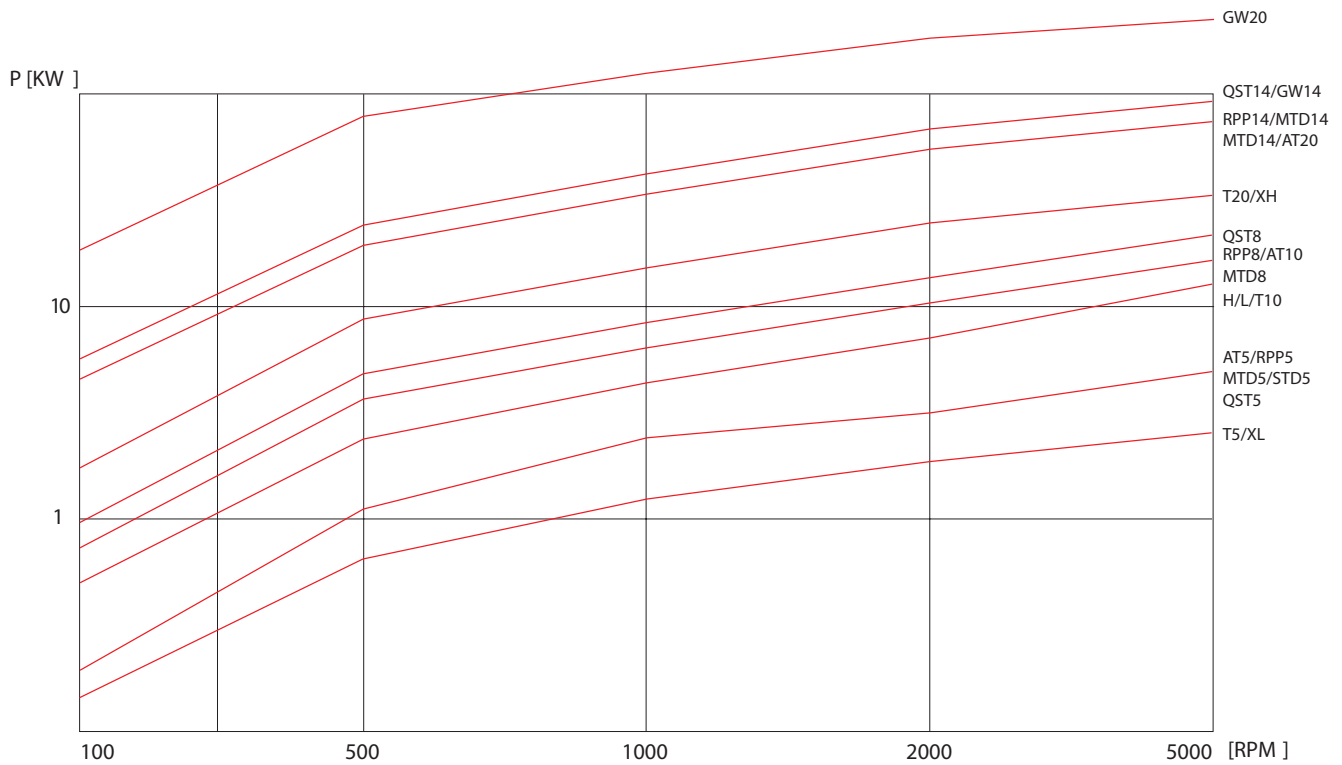

Table n. 1

BELT WIDTH SELECTION

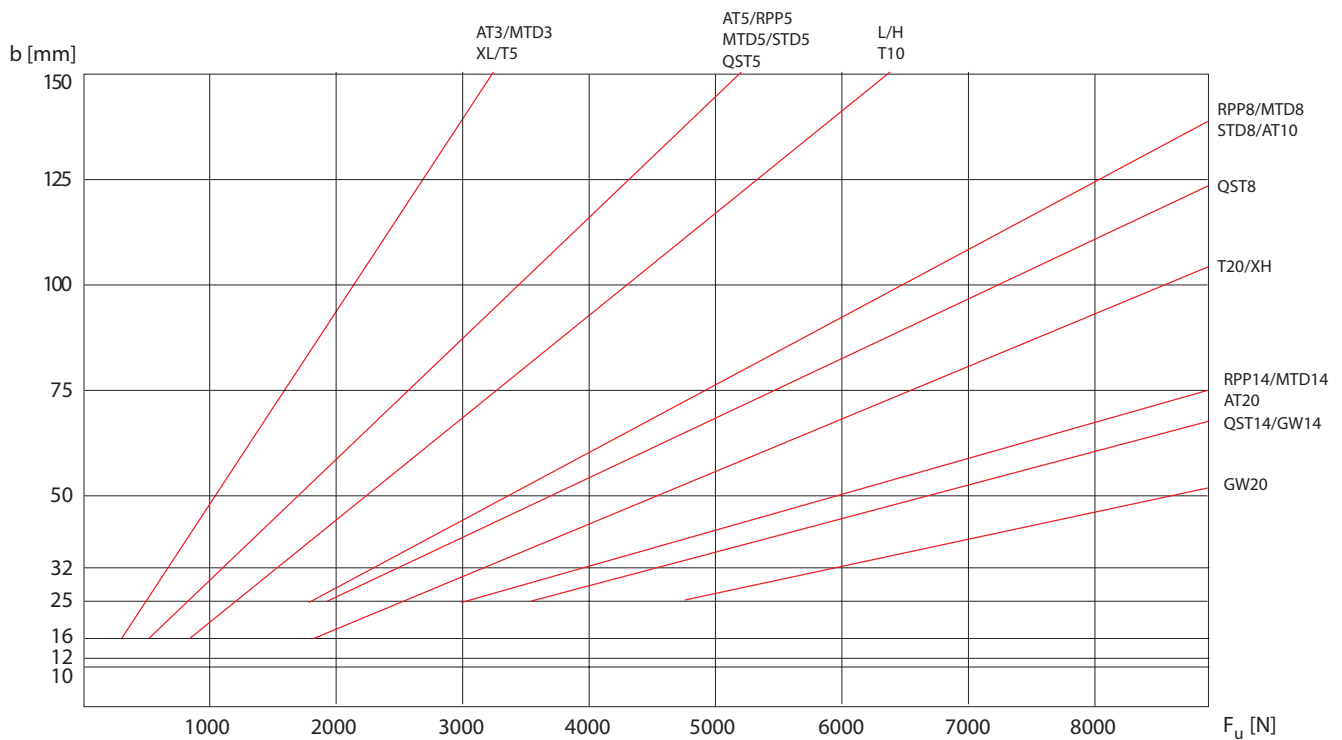

Table n. 2

Average values valid for standard steel cord. After belt selection, please check belt resistance on belt data page.

Table n. 3 - Friction coefficient

Sliding friction on dry surface	
Polyurethane / smooth steel	$\mu = 0,5$
Polyurethane / rough steel	$\mu = 0,7$
Polyurethane / abrasive steel	$\mu = 0,9$
Polyurethane NFT / smooth steel	$\mu = 0,25$
Polyurethane NFT / rough steel	$\mu = 0,35$
Polyurethane NFT / abrasive steel	$\mu = 0,6$
Polyurethane / nylon	$\mu = 0,35$
Polyurethane NFT / nylon	$\mu = 0,15$
Polyurethane / aluminium	$\mu = 0,8$
Polyurethane NFT / aluminium	$\mu = 0,45$
Rolling friction on dry surface	
Bearing	$\mu = 0,015$
Roller / PU Belt	$\mu = 0,03 / 0,06$
Bush	$\mu = 0,15$

Table n. 4 - Safety factor

The choice of the Safety factor's, depends on the operating conditions.
The following table shows the value to be used:

Steady Load		1
Shock Load	Low	1,4
	Average	1,7
	High	2
Elevators, hoists		1,8
Line shafts		1,6
Paper machines:		
agitators, calenders, driers, winding frames,		1,6
willows, Jordan machines, pumps, slicers, grinders		1,8
Machines for pottery and earthenware:		
cutters, granulators,		1,7
pulping machines		2,0
Laundry machines: general		1,6
extractors, washers		1,8
Machines for rubber processing		1,8
Woodworking machines:		
lathes, band saws, cutters,		1,7
circular saws, planers, jointer		1,7
Printing machinery:		
rotary, newspaper, linotype, cutters, folders, magazine		1,6
Textile machines:		
warping machines, winders,		1,7
spinners, twisting frames, looms		1,8
Machines tools: drilling machines, lathes,		
tread cutting machines, gears cutters, boring machines		1,6
millers, planers,		1,7
grinding machines		1,7
Conveyors:		
hoists, light package		1,3
oven screw fleight		1,8
apron bucket, elevator		1,8
screw		1,8
Brick machinery		1,8

BELT INSTALLATION

A major difficulty installing transmission belt is to achieve correct belt tension. Lifetime of support bearings and transmission belts and therefore reliability of the complete system largely depends on an optimally adjusted belt tension. Pretension is the force needed to put tension into the system to avoid the belt jumping on the pulleys as in the example below:

Not correct belt installation

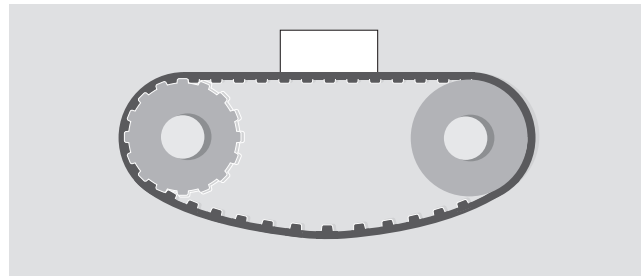

For a correct system installation, all applications with Megalinear belt can be summarised according following two sketches:

1) Linear and omega linear motion belt

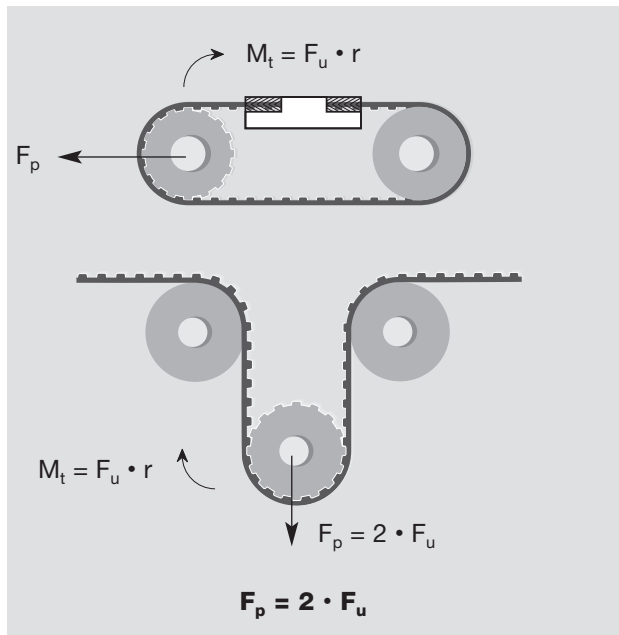

2) Conveyor belt

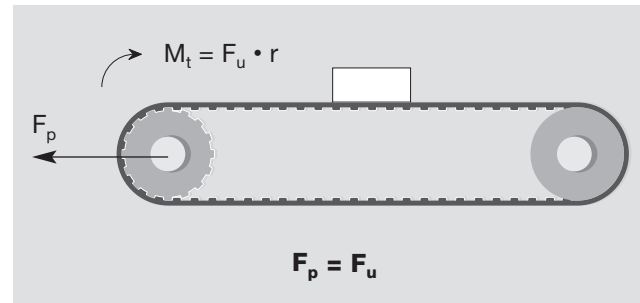

F_p = pretension
 F_u = peripheral force (see calculation pag. 8/9)
 r = pulley radius

PROCEDURE TO MEASURE

The procedure to measure the tension of the belt is to use a Belt Tension Gauging Equipment. This device consists of a small sensing head which is held across the belt to be measured. The belt is then tapped to induce the belt to vibrate at its natural frequency. The vibrations are detected and the frequency of vibration is then displayed on the measuring unit. The relation between belt static tension (T_s) and frequency of vibration (f) may be calculated using the following formula:



$$f = \frac{1}{2t} \cdot \sqrt{\frac{T_s}{m}} \quad \text{or} \quad T_s = 4 \cdot m \cdot t^2 \cdot f^2$$

Where :

T_s = static tension (N)

f = Frequency of vibration in Hertz (Hz)

m = Belt mass per unit length (kg/m)

t = Free belt span length in meters (m)

BELT INSTALLATION

For a correct system functioning and to increase belt life, it is necessary a correct pulley installation: pulleys has to be parallel and aligned as shown in drawing 1 (correct configuration).

If pulleys are not parallel as in drawing 2, belt could fall during functioning and this can provoke damages to complete equipment.

To grant a correct belt running, α and Δx must be as smaller as possible. For more information, please contact our technical staff.

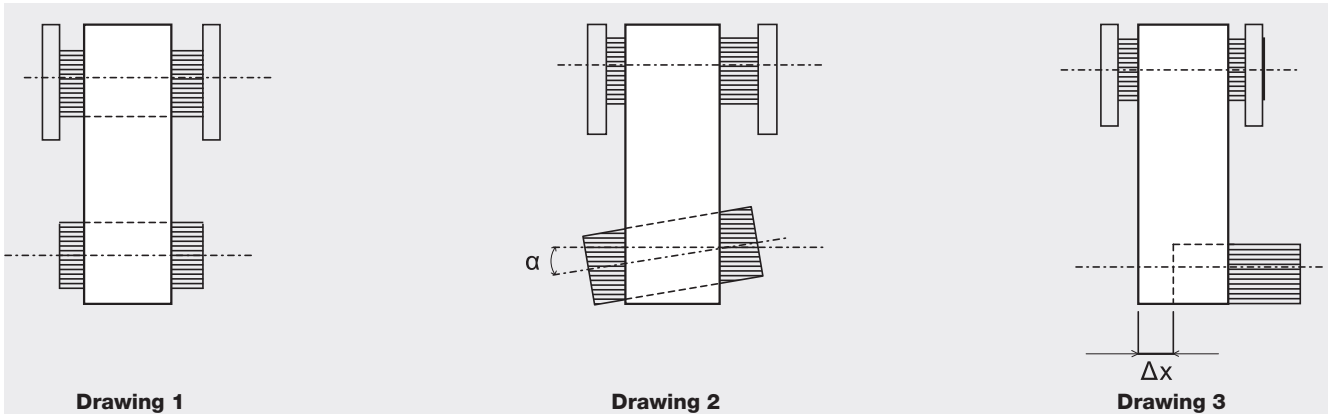

In omega application to grant good mesh between pulley and teeth and to respect belt flexibility avoiding excessive stress on cords, distance d (as drawing 4) has to be:

$d = 4 \cdot \text{belt width}$
Suggested angle 120°

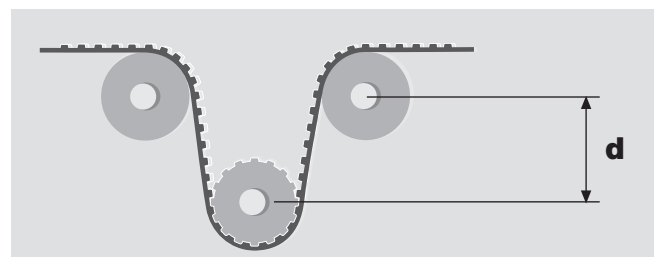

Drawing 4

Moreover for a good drive work, it is suggested to check belt straightness as follows:

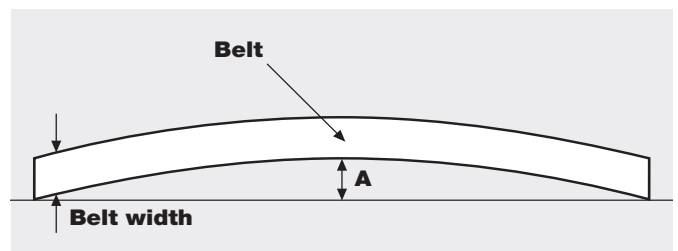

Belt width	Testing belt length	Maximum suggested bending (A)
Till to 20 mm	1 m	3 mm
Over 20 mm	2 m	4 mm

MEGALINEAR MXL OPEN-END

BELT CHARACTERISTICS

STANDARD WIDTHS (inch)	017	037	050
STANDARD WIDTHS (mm)	4,318	9,53	12,7
Weight (gr/m)	8	16	24

Standard compound: **white Polyurethane thermoplastic 92 ShA**

Standard back cover: **none**

Standard tooth cover: **none**

Standard cords: **S and Z torsion kevlar cords**

Standard width tolerance: **+/- 0,38 mm**

Standard thickness: **1,14 +/- 0,13 mm**

Standard length tolerance: **+/- 0,8 mm/m**

Standard roll length: **100 m**

Belt options on request with minimum quantity:
Antistatic compound

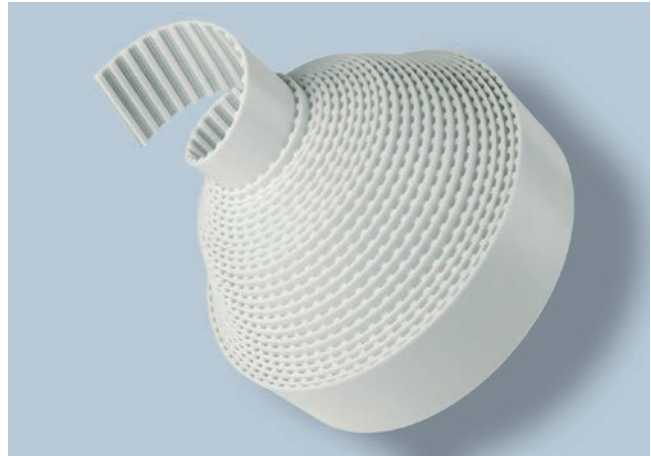

TOOTH PROFILE ACCORDING ISO 5296-1

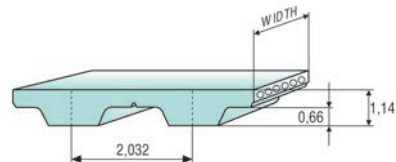

TOOTH RESISTANCE

RPM (1/min)	0	20	40	60	80	100	200	300	400	500	750	1000	1500	2000	3000	4000
F _{p spec} (N/cm)	7,3	7	6,8	6,7	6,6	6,4	5,9	5,7	5,4	5,2	4,9	4,6	4,2	4	3,6	3,25

Minimum suggested number of teeth in clamp for linear movement: 7

TRACTION RESISTANCE

	Belt width (inch)	017	037	050
Kevlar	Max Traction Load (N)	210	420	630
	Breaking Strength (N)	850	1700	2550
	Elongation at MTL (mm/m)	8	8	8

Average values

FLEXION RESISTANCE

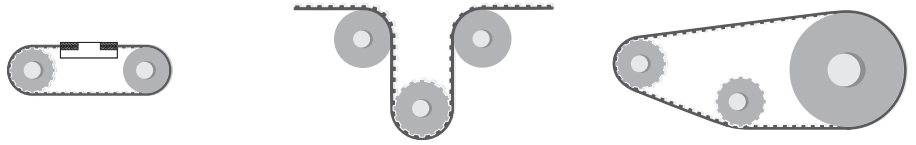

	Z_{min}	Z_{min}	Idler min dia (mm)	Z_{min}	Idler min dia (mm)
Kevlar cords	12	15	30	12	20

PULLEYS (for more details please see our pulleys catalogue)

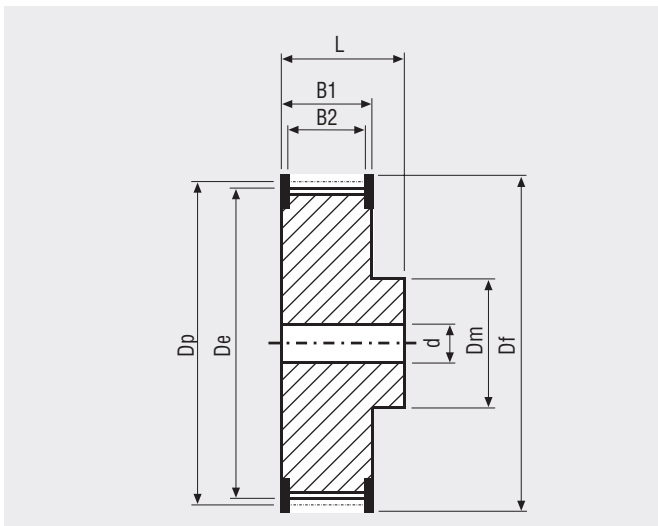

N° Teeth	Dp	De	N° Teeth	Dp	De
10	6,47	5,96	26	16,81	16,30
12	7,76	7,25	28	18,11	17,60
13	8,41	7,90	30	19,40	18,89
14	9,06	8,55	32	20,70	20,19
15	9,70	9,19	34	21,99	21,48
16	10,35	9,84	36	23,29	22,78
17	11,00	10,49	40	25,87	25,36
18	11,64	11,13	42	27,17	26,66
19	12,29	11,78	44	28,46	27,95
20	12,94	12,43	48	31,05	30,54
21	13,58	13,07	60	38,81	38,30
22	14,23	13,72	65	42,04	41,53
24	15,52	15,01	72	46,57	46,06

MEGALINEAR XL OPEN-END

BELT CHARACTERISTICS

STANDARD WIDTHS (inch)	025	037	050	075	100	150	200
STANDARD WIDTHS (mm)	6,35	9,53	12,7	19,05	25,4	38,1	50,8
Weight (gr/m)	15	20	30	45	60	90	120

Standard compound: **white Polyurethane thermoplastic 92 ShA**

Standard back cover: **none**

Standard tooth cover: **none**

Standard cords: **S and Z torsion zinked steel**

Standard width tolerance: **+/- 0,5 mm**

Standard thickness: **2,3 +/- 0,3 mm**

Standard length tolerance: **+/- 0,8 mm/m**

Standard roll length: **100 m**

Belt options on request with minimum quantity:

- Nylon fabric back
- Nylon fabric teeth
- Antistatic nylon fabric
- Transparent FDA compound
- AVAFC 60/70/85 ShA
- APL
- Cleats

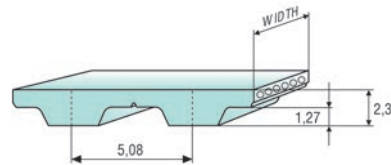
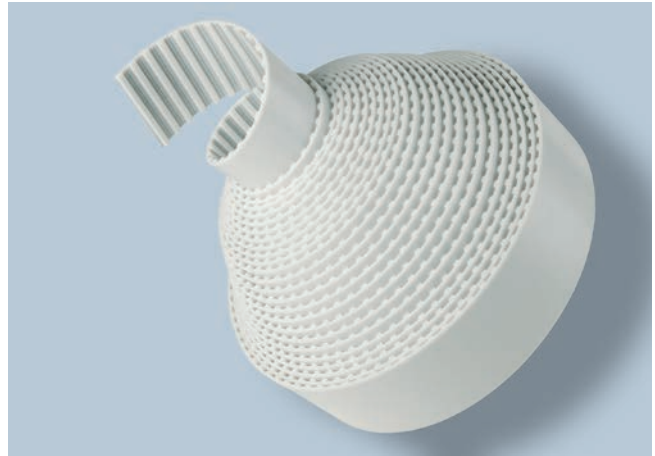

Different back coating materials see page 118

TOOTH PROFILE ACCORDING ISO 5296-1

TOOTH RESISTANCE

RPM (1/min)	0	20	40	60	80	100	200	300	400	500	750	1000	1500	2000	3000	4000	5000	8000
F _{p spec} (N/cm)	19	19	18	18	17	17	16	15	15	14	13	13	12	11	10	9	8	7

Minimum suggested number of teeth in clamp for linear movement: 7

TRACTION RESISTANCE

Belt width (inch)		025	037	050	075	100	150	200
Steel	Max Traction Load (N)	155	250	375	625	840	1310	1750
	Breaking Strength (N)	625	1000	1500	2500	3375	5250	7000
	Elongation at MTL (mm/m)	4	4	4	4	4	4	4
Kevlar	Max Traction Load (N)	210	335	505	845	1140	1775	2365
	Breaking Strength (N)	845	1350	2025	3380	4565	7100	9465
	Elongation at MTL (mm/m)	8	8	8	8	8	8	8
Stainless	Max Traction Load (N)	85	140	210	355	480	-	-
	Breaking Strength (N)	355	570	855	1425	1920	-	-
	Elongation at MTL (mm/m)	3,8	3,8	3,8	3,8	3,8	-	-

Average values

FLEXION RESISTANCE

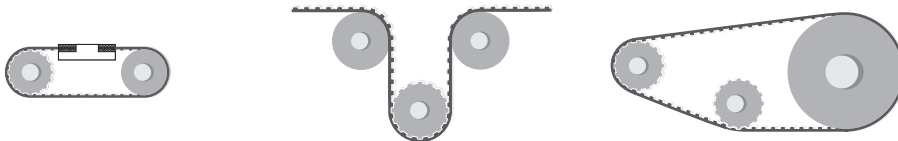

	Z_{min}	Z_{min}	Idler min dia (mm)	Z_{min}	Idler min dia (mm)
Standard steel cords	10	15	30	10	30
Kevlar cords	10	15	30	10	20
Stainless steel cords	13	15	35	13	35

JOINED BELT INFORMATIONS

- Minimum splice length 900 mm
- Traction and tooth resistances = 50% less than open-end
- Joined belt can be used only in conveyor systems
- Rolls with NFT, NFB, AVAFC and APL can be joined too
- Minimum diameters according above table
- For coated belts, minimum diameters on page 118



PULLEYS (for more details please see our pulleys catalogue)

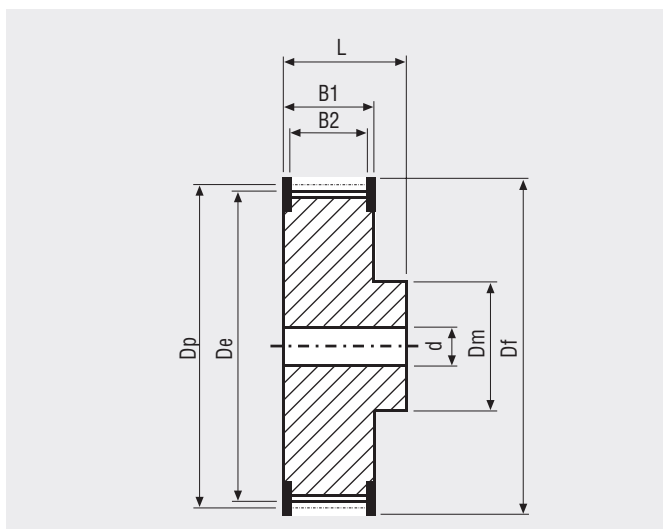

N° Teeth	Dp	De	N° Teeth	Dp	De
10	16,17	15,66	26	42,04	41,53
11	17,79	17,28	27	43,67	43,16
12	19,40	18,89	28	45,28	44,77
13	21,02	20,51	29	46,89	46,38
14	22,64	22,13	30	48,51	48,00
15	24,26	23,75	32	51,74	51,23
16	25,87	25,36	34	54,98	54,47
17	27,49	26,98	35	56,60	56,09
18	29,11	28,60	36	58,21	57,70
19	30,72	30,21	38	61,45	60,94
20	32,34	31,83	39	63,06	62,55
21	33,96	33,45	40	64,68	64,17
22	35,57	35,07	42	67,91	67,40
24	38,81	38,30	44	71,15	70,64

MEGALINEAR L OPEN-END

BELT CHARACTERISTICS

STANDARD WIDTHS (inch)	037	050	075	100	150	200	400
STANDARD WIDTHS (mm)	9,53	12,7	19,05	25,4	38,1	50,8	101,6
Weight (gr/m)	35	45	65	90	135	180	325

Standard compound: **white Polyurethane thermoplastic 92 ShA**

Standard back cover: **none**

Standard tooth cover: **none**

Standard cords: **S and Z torsion zinked steel**

Standard width tolerance: **+/- 0,5 mm**

Standard thickness: **3,6 +/- 0,3 mm**

Standard length tolerance: **+/- 0,8 mm/m**

Standard roll length: **100 m**

Belt options on request with minimum quantity:

- Nylon fabric back
- Nylon fabric teeth
- Antistatic nylon fabric
- Transparent FDA compound
- AVAFC 60/70/85 ShA
- APL
- Cleats

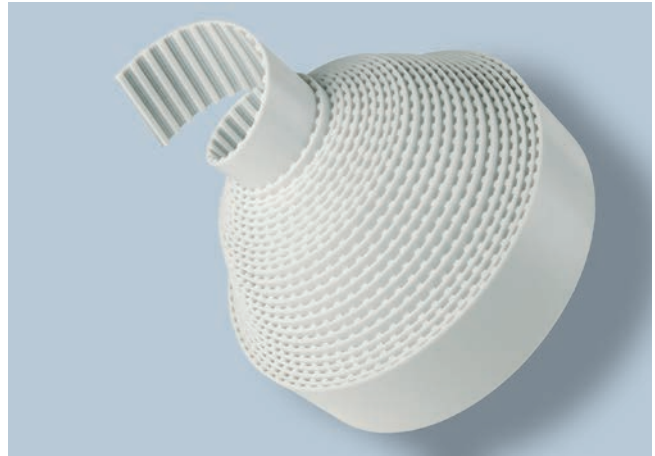

Different back coating materials see page 118

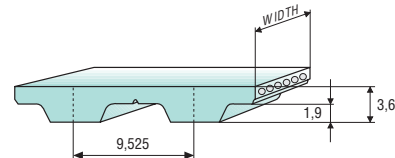

TOOTH PROFILE ACCORDING ISO 5296-1

TOOTH RESISTANCE

RPM (1/min)	0	20	40	60	80	100	200	300	400	500	750	1000	1500	2000	3000	4000	5000	8000
F _{p spec} (N/cm)	37	36	35	35	34	33	31	29	28	27	24	23	20	19	16	15	13	11

Minimum suggested number of teeth in clamp for linear movement: 7

TRACTION RESISTANCE

Belt width (inch)		037	050	075	100	150	200	400
Steel	Max Traction Load (N)	600	800	1340	1805	2810	3750	7500
	Breaking Strength (N)	2410	3215	5360	7235	11255	15005	26260
	Elongation at MTL (mm/m)	4	4	4	4	4	4	4
Kevlar	Max Traction Load (N)	595	795	1330	1795	2790	3720	7445
	Breaking Strength (N)	2390	3190	5320	7180	11170	14895	26065
	Elongation at MTL (mm/m)	8	8	8	8	8	8	8
Stainless	Max Traction Load (N)	470	625	1045	1410	-	-	-
	Breaking Strength (N)	1880	2505	4180	5640	-	-	-
	Elongation at MTL (mm/m)	3,8	3,8	3,8	3,8	-	-	-

Average values

FLEXION RESISTANCE



	Z_{min}	Z_{min}	Idler min dia (mm)	Z_{min}	Idler min dia (mm)
Standard steel cords	15	20	60	15	60
Kevlar cords	15	20	60	15	60
Stainless steel cords	18	20	65	18	65

JOINED BELT INFORMATIONS

- Minimum splice length 900 mm
- Traction and tooth resistances = 50% less than open-end
- Joined belt can be used only in conveyor systems
- Rolls with NFT, NFB, AVAFC and APL can be joined too
- Minimum diameters according above table
- For coated belts, minimum diameters on page 118



PULLEYS (for more details please see our pulleys catalogue)

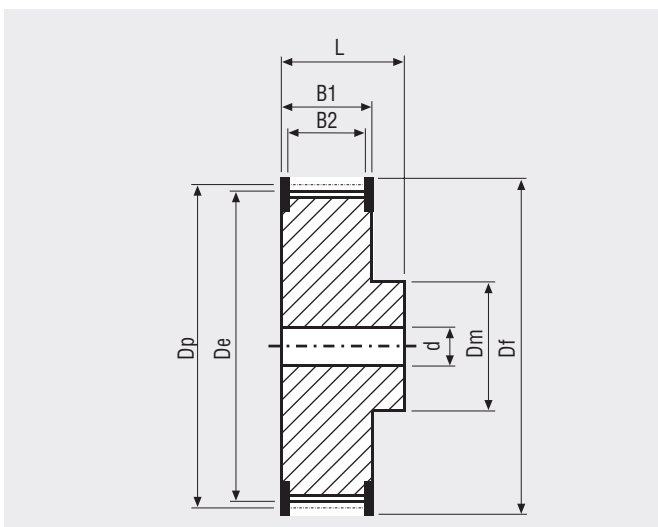

N° Teeth	Dp	De	N° Teeth	Dp	De
15	45,48	44,72	27	81,86	81,10
16	48,51	47,75	28	84,89	84,13
17	51,54	50,78	29	87,93	87,17
18	54,57	53,81	30	90,96	90,20
19	57,61	56,85	32	97,02	96,26
20	60,64	59,88	34	103,08	102,32
21	63,67	62,91	36	109,15	108,39
22	66,70	65,94	40	121,28	120,52
23	69,73	68,97	44	133,40	132,64
24	72,77	72,01	48	145,53	144,76
25	75,80	75,04	56	169,79	169,03
26	78,83	78,07			

MEGALINEAR H OPEN-END

BELT CHARACTERISTICS

STANDARD WIDTHS (inch)	050	075	100	150	200	300	400	600
STANDARD WIDTHS (mm)	12,7	19,05	25,4	38,1	50,8	76,2	101,6	152,4
Weight (gr/m)	55	80	110	160	215	325	430	645

Standard compound: **white Polyurethane thermoplastic 92 ShA**

Standard back cover: **none**

Standard tooth cover: **none**

Standard cords: **S and Z torsion zinked steel**

Standard width tolerance: **+/- 0,5 mm**

Standard thickness: **4,3 +/- 0,3 mm**

Standard length tolerance: **+/- 0,8 mm/m**

Standard roll length: **100 m**

Belt options on request with minimum quantity:

- Nylon fabric back
- Nylon fabric teeth
- Antistatic nylon fabric
- Transparent FDA compound
- AVAFC 60/70/85 ShA
- APL
- Cleats

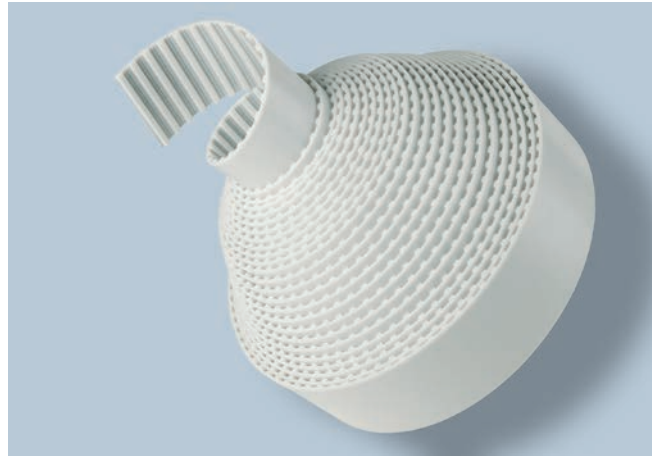

Different back coating materials see page 118

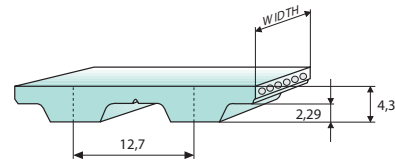

TOOTH PROFILE ACCORDING ISO 5296-1

TOOTH RESISTANCE

RPM (1/min)	0	20	40	60	80	100	200	300	400	500	750	1000	1500	2000	3000	4000	5000	8000
F _{p spec} (N/cm)	44	43	42	41	40	39	36	34	33	31	29	27	24	22	19	17	16	12

Minimum suggested number of teeth in clamp for linear movement: 7

TRACTION RESISTANCE

Belt width (inch)		050	075	100	150	200	300	400	600
Steel	Max Traction Load (N)	1050	1785	2415	3675	5040	8065	11760	12480
	Breaking Strength (N)	4200	7140	9660	14700	20160	30660	41160	43680
	Elongation at MTL (mm/m)	4	4	4	4	4	4	4	4
Kevlar	Max Traction Load (N)	895	1535	2050	3205	4360	7020	10260	15240
	Breaking Strength (N)	3590	6155	8205	12825	17440	26675	35910	53350
	Elongation at MTL (mm/m)	8	8	8	8	8	8	8	8
Stainless	Max Traction Load (N)	805	1370	1855	2825	3875	-	-	-
	Breaking Strength (N)	3230	5490	7425	11305	15500	-	-	-
	Elongation at MTL (mm/m)	3,8	3,8	3,8	3,8	3,8	-	-	-

Average values

FLEXION RESISTANCE

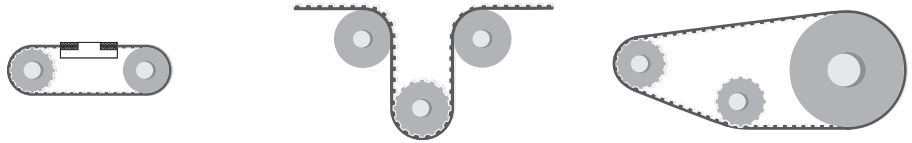

	Z_{min}	Z_{min}	Idler min dia (mm)	Z_{min}	Idler min dia (mm)
Standard steel cords	14	20	80	14	60
Kevlar cords	14	20	80	14	60
Stainless steel cords	18	20	80	18	65

JOINED BELT INFORMATIONS

- Minimum splice length 900 mm
- Traction and tooth resistances = 50% less than open-end
- Joined belt can be used only in conveyor systems
- Rolls with NFT, NFB, AVAFC and APL can be joined too
- Minimum diameters according above table
- For coated belts, minimum diameters on page 118



PULLEYS (for more details please see our pulleys catalogue)

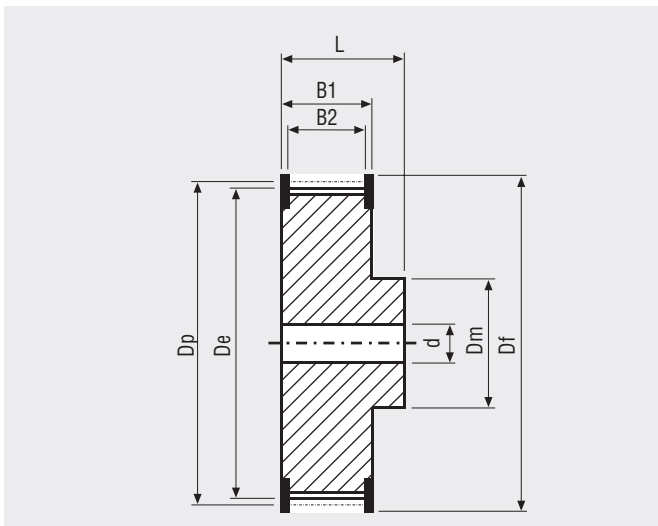

N° Teeth	Dp	De	N° Teeth	Dp	De
14	56,60	55,23	28	113,19	111,82
15	60,64	59,27	29	117,23	115,86
16	64,68	63,31	30	121,28	119,91
17	68,72	67,35	32	129,36	127,99
18	72,77	71,40	33	133,40	132,03
19	76,81	75,44	34	137,45	136,08
20	80,85	79,48	35	141,49	140,12
21	84,89	83,52	36	145,53	144,16
22	88,94	87,57	38	153,62	152,25
23	92,98	91,61	40	161,70	160,33
24	97,02	95,65	44	177,87	176,50
25	101,06	99,69	48	194,04	192,67
26	105,11	103,74	52	210,21	208,84
27	109,15	107,78	60	242,55	241,18

MEGALINEAR H WIDE OPEN-END

BELT CHARACTERISTICS

STANDARD WIDTHS (inch)	800	1000	1200	1600	2000
STANDARD WIDTHS (mm)	203,2	254	304,8	406,4	508
Weight (gr/m)	410	510	615	820	1020

Standard compound: **transparent Polyurethane thermoplastic 92 ShA**

Standard back cover: **none**

Standard tooth cover: **none**

Standard cords: **S and Z torsion kevlar at pitch 3,2 mm**

Standard width tolerance: **+/- 0,2 mm**

Standard thickness: **4,3 +/- 0,3 mm**

Standard length tolerance: **+/- 0,8 mm/m**

Standard roll length: **100 m**

Belt options on request with minimum quantity:

- Nylon fabric back
- Nylon fabric teeth
- Antistatic nylon fabric
- Transparent FDA compound

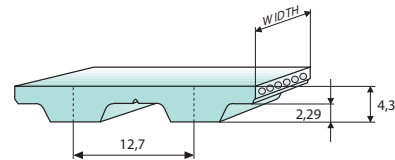
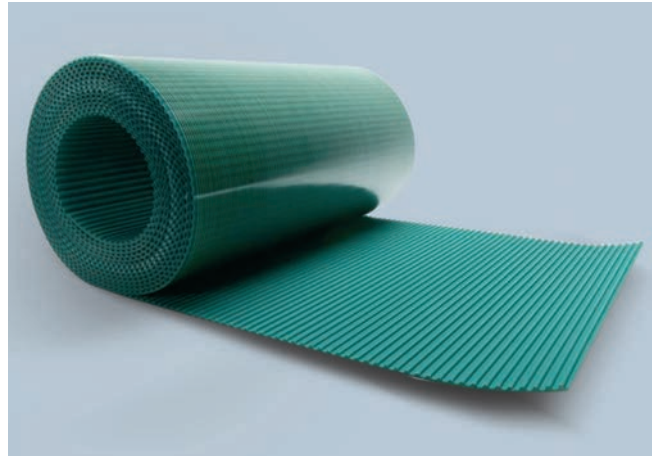

TOOTH PROFILE ACCORDING ISO 5296-1

TOOTH RESISTANCE

RPM (1/min)	0	20	40	60	80	100	200	300	400	500	750	1000
F _{p spec} (N/cm)	31	30	29	29	28	27	25	24	23	21	20	19

TRACTION RESISTANCE

	Belt width (inch)	800	1000	1200	1600	2000
Kevlar	Max Traction Load (N)	8350	10260	12310	16415	20520
	Breaking Strength (N)	29240	35910	43090	57455	71820
	Elongation at MTL (mm/m)	8	8	8	8	8

Average values

FLEXION RESISTANCE

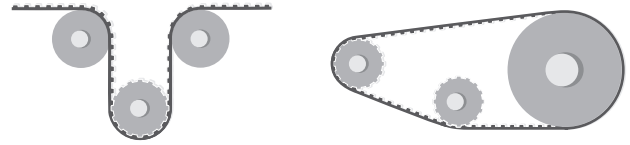

	Z_{min}	Idler min dia (mm)	Z_{min}	Idler min dia (mm)
Kevlar cords	20	80	14	60

JOINED BELT INFORMATIONS

- Traction and tooth resistances = 50% less than open-end
- Joined belt can be used only in conveyor systems
- Rolls with NFT and NFB can be joined too
- Minimum diameters according above table



PULLEYS (for more details please see our pulleys catalogue)

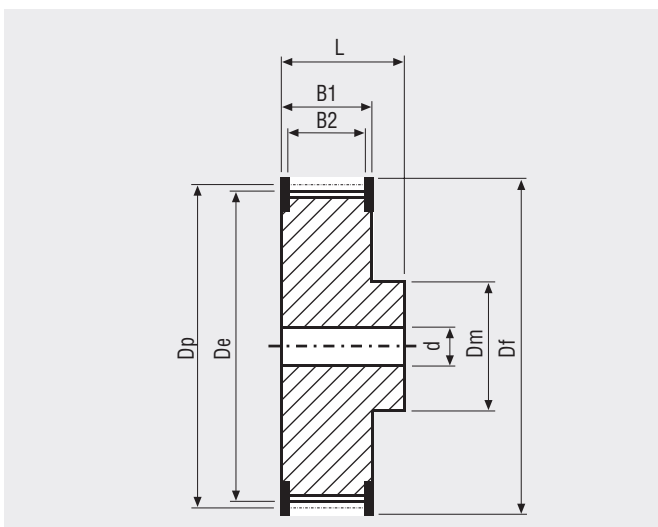

N° Teeth	Dp	De	N° Teeth	Dp	De
14	56,60	55,23	28	113,19	111,82
15	60,64	59,27	29	117,23	115,86
16	64,68	63,31	30	121,28	119,91
17	68,72	67,35	32	129,36	127,99
18	72,77	71,40	33	133,40	132,03
19	76,81	75,44	34	137,45	136,08
20	80,85	79,48	35	141,49	140,12
21	84,89	83,52	36	145,53	144,16
22	88,94	87,57	38	153,62	152,25
23	92,98	91,61	40	161,70	160,33
24	97,02	95,65	44	177,87	176,50
25	101,06	99,69	48	194,04	192,67
26	105,11	103,74	52	210,21	208,84
27	109,15	107,78	60	242,55	241,18

MEGALINEAR XH OPEN-END

BELT CHARACTERISTICS

STANDARD WIDTHS (inch)	100	150	200	300	400	600
STANDARD WIDTHS (mm)	25,4	38,1	50,8	76,2	101,6	152,4
Weight (gr/m)	250	400	530	795	1060	1625

- Standard compound: **white Polyurethane thermoplastic 92 ShA**
- Standard back cover: **none**
- Standard tooth cover: **none**
- Standard cords: **S and Z torsion zinked steel**
- Standard width tolerance: **+/- 1 mm**
- Standard thickness: **11,2 +/- 0,5 mm**
- Standard length tolerance: **+/- 0,8 mm/m**
- Standard roll length: **100 m**
- Belt options on request with minimum quantity:
- Nylon fabric back
 - Nylon fabric teeth
 - Antistatic nylon fabric
 - Transparent FDA compound
 - AVAFC 60/70/85 ShA
 - APL
 - Fishbone
 - Ribbed
 - Cleats

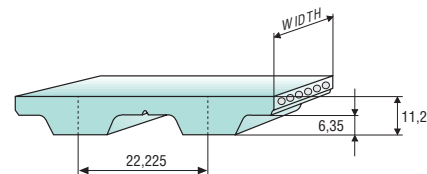
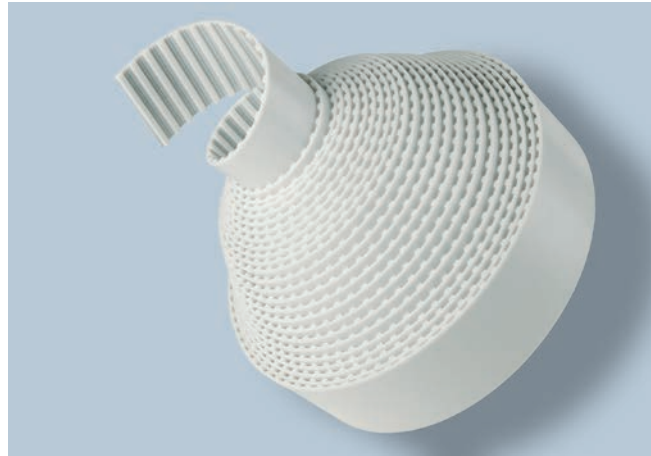

Different back coating materials see page 118

TOOTH PROFILE ACCORDING ISO 5296-1

TOOTH RESISTANCE

RPM (1/min)	0	20	40	60	80	100	200	300	400	500	750	1000	1500	2000	3000	4000
F _{p spec} (N/cm)	115	111	108	105	103	101	92	86	81	78	70	65	57	51	43	37

Minimum suggested number of teeth in clamp for linear movement: 7

TRACTION RESISTANCE

Belt width (inch)		100	150	200	300	400	600
Steel	Max Traction Load (N)	3800	5935	8075	13000	19000	28225
	Breaking Strength (N)	15200	23750	32300	49400	66500	98800
	Elongation at MTL (mm/m)	4	4	4	4	4	4
Kevlar	Max Traction Load (N)	4215	6675	9135	14800	21690	32940
	Breaking Strength (N)	16870	26710	36555	56240	75920	115290
	Elongation at MTL (mm/m)	8	8	8	8	8	8
Stainless	Max Traction Load (N)	2865	4480	6095	-	-	-
	Breaking Strength (N)	11475	17930	24385	-	-	-
	Elongation at MTL (mm/m)	3,8	3,8	3,8	-	-	-

Average values

FLEXION RESISTANCE

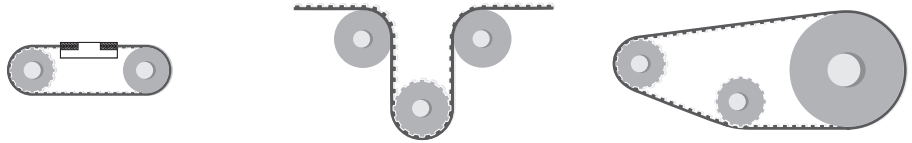

	Z_{min}	Z_{min}	Idler min dia (mm)	Z_{min}	Idler min dia (mm)
Standard steel cords	18	20	180	18	150
Kevlar cords	18	20	180	18	150
Stainless steel cords	23	25	180	23	165

JOINED BELT INFORMATIONS

- Minimum splice length 900 mm
- Traction and tooth resistances = 50% less than open-end
- Joined belt can be used only in conveyor systems
- Rolls with NFT, NFB, AVAFC and APL can be joined too
- Minimum diameters according above table
- For coated belts, minimum diameters on page 118

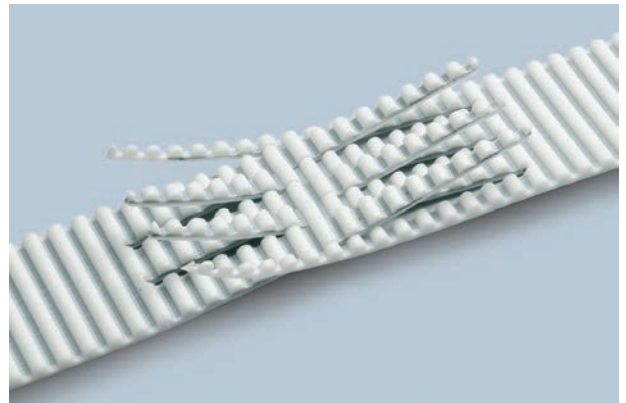

PULLEYS (for more details please see our pulleys catalogue)

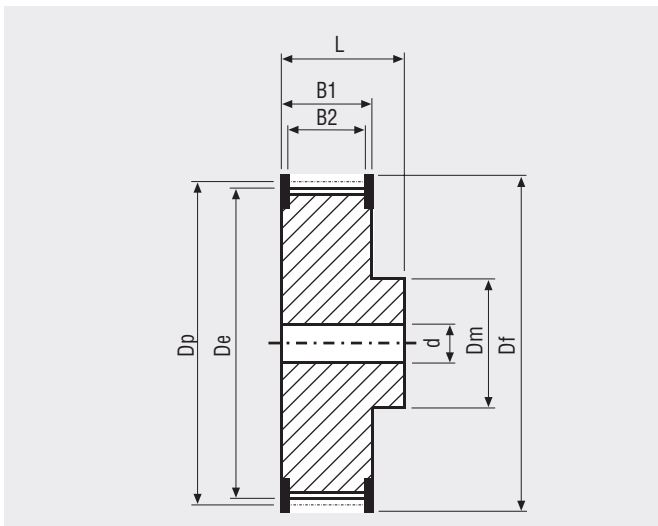

N° Teeth	Dp	De	N° Teeth	Dp	De
18	127,34	124,55	40	282,98	280,19
20	141,49	138,70	44	311,28	308,48
22	155,64	152,83	48	339,57	336,78
24	169,79	167,00	60	424,47	421,68
26	183,92	181,13	72	509,36	506,57
28	198,08	195,29	84	594,25	591,46
30	212,23	209,44	96	679,15	676,35
32	226,38	223,59	120	848,93	846,14

MEGALINEAR T2,5 OPEN-END

BELT CHARACTERISTICS

STANDARD WIDTHS (mm)	10	16	20
Weight (gr/m)	14	23	28

Standard compound: **white Polyurethane thermoplastic 92 ShA**
 Standard back cover: **none**
 Standard tooth cover: **none**
 Standard cords: **one torsion zinked steel**
 Standard width tolerance: **+/- 0,3 mm**
 Standard thickness: **1,3 +/- 0,15 mm**
 Standard length tolerance: **+/- 0,8 mm/m**
 Standard roll length: **100 m**

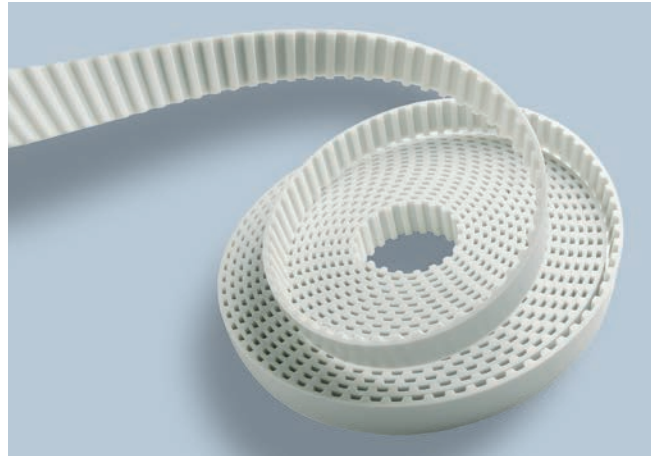

TOOTH PROFILE ACCORDING ISO 17396

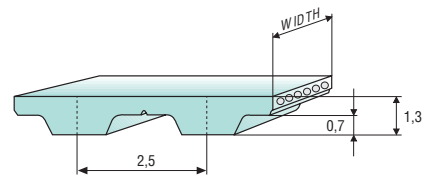

TOOTH RESISTANCE

RPM (1/min)	0	20	40	60	80	100	200	300	400	500	750	1000	1500	2000	3000	4000
F _{p spec} (N/cm)	9	8,7	8,4	8,2	8,1	7,9	7,3	7	6,7	6,4	6	5,7	5,2	4,9	4,4	4

Minimum suggested number of teeth in clamp for linear movement: 7

TRACTION RESISTANCE

Belt width (mm)		10	16	20
Steel	Max Traction Load (N)	105	170	215
	Breaking Strength (N)	435	695	870
	Elongation at MTL (mm/m)	4	4	4

Average values

FLEXION RESISTANCE



	Z_{min}	Z_{min}	Idler min dia (mm)	Z_{min}	Idler min dia (mm)
Standard steel cord	10	18	15	10	18

JOINED BELT INFORMATIONS

- Minimum splice length 500 mm
- Traction and tooth resistances = 50% less than open-end
- Joined belt can be used only in conveyor systems
- Minimum diameters according above table

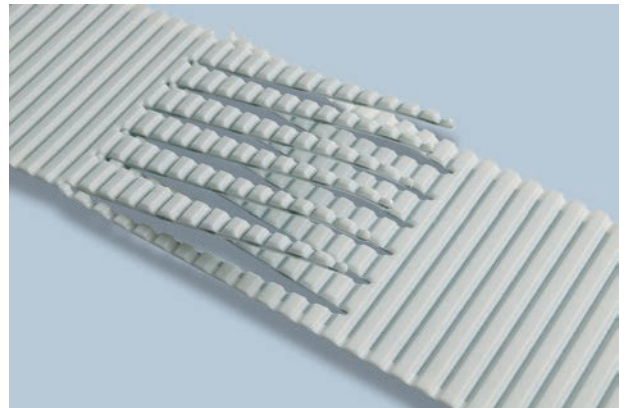

PULLEYS (for more details please see our pulleys catalogue)

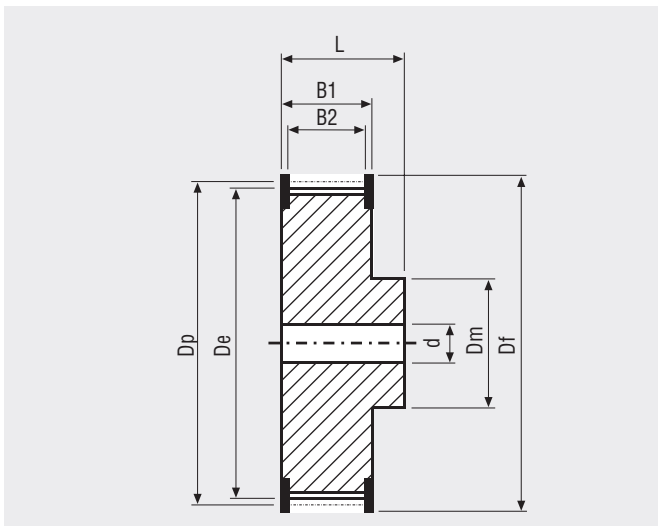

N° Teeth	Dp	De	N° Teeth	Dp	De
10	7,96	7,45	22	17,51	17,00
11	8,75	8,25	24	19,10	18,55
12	9,55	9,00	26	20,69	20,15
13	10,34	9,80	28	22,28	21,75
14	11,14	10,60	30	23,87	23,35
15	11,94	11,40	32	25,46	24,95
16	12,73	12,20	36	28,65	28,10
17	13,53	13,00	40	31,83	31,30
18	14,32	13,80	44	35,01	34,50
19	15,12	14,60	48	38,20	37,70
20	15,92	15,40	60	47,75	47,25
21	16,71	16,20	72	55,20	55,20

MEGALINEAR T5 OPEN-END

BELT CHARACTERISTICS

STANDARD WIDTHS (mm)	6	10	16	25	32	50	75	100	150
Weight (gr/m)	15	20	35	55	70	105	160	215	330

- Standard compound: **white Polyurethane thermoplastic 92 ShA**
- Standard back cover: **none**
- Standard tooth cover: **none**
- Standard cords: **S and Z torsion zinked steel**
- Standard width tolerance: **+/- 0,5 mm**
- Standard thickness: **2,2 +/- 0,15 mm**
- Standard thickness with NFT-NFB: **2,4 +/- 0,15 mm***
- Standard length tolerance: **+/- 0,8 mm/m**
- Standard roll length: **100 m**
- Belt options on request with minimum quantity:
- Nylon fabric back
 - Nylon fabric teeth
 - Antistatic nylon fabric
 - Transparent FDA compound
 - AVAFC 60/70/85 ShA
 - APL
 - Fishbone
 - Ribbed
 - Cleats

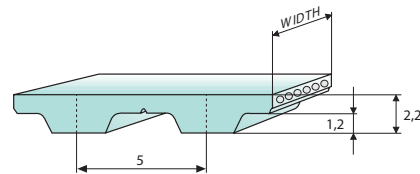
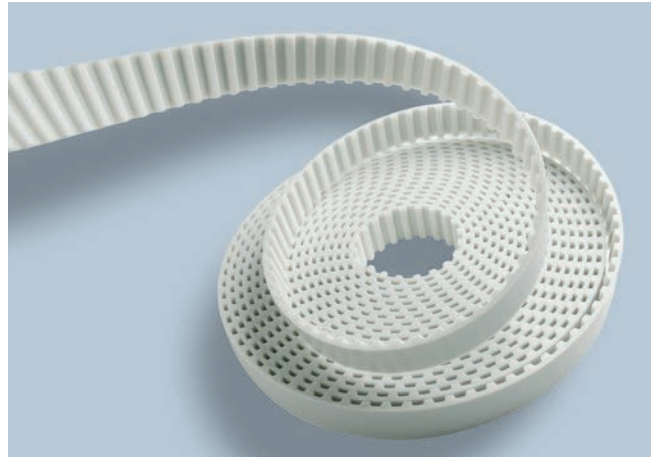

Different back coating materials see page 118

TOOTH PROFILE ACCORDING ISO 17396

TOOTH RESISTANCE

RPM (1/min)	0	20	40	60	80	100	200	300	400	500	750	1000	1500	2000	3000	4000	5000	8000
F _{p spec} (N/cm)	24	23	23	22	22	22	20	19	19	18	17	16	15	14	12	11	11	9

Minimum suggested number of teeth in clamp for linear movement: 7

TRACTION RESISTANCE

Belt width (mm)		6	10	16	25	32	50	75	100	150
Steel	Max Traction Load (N)	185	375	500	840	1060	1750	2400	3220	3640
	Breaking Strength (N)	750	1500	2000	3375	4250	7000	9125	12250	12750
	Elongation at MTL (mm/m)	4	4	4	4	4	4	4	4	4
Kevlar	Max Traction Load (N)	395	795	1060	1795	2260	3720	5110	6860	7750
	Breaking Strength (N)	1595	3190	4255	7180	9040	14895	19415	26065	27130
	Elongation at MTL (mm/m)	8	8	8	8	8	8	8	8	8
HP	Max Traction Load (N)	-	585	780	1315	1655	2730	3745	5025	-
	Breaking Strength (N)	-	2340	3120	5265	6630	10920	14235	19110	-
	Elongation at MTL (mm/m)	-	4	4	4	4	4	4	4	-
HF	Max Traction Load (N)	-	490	655	1105	1390	2295	3150	4225	-
	Breaking Strength (N)	-	1965	2620	4425	5575	9180	11970	16070	-
	Elongation at MTL (mm/m)	-	5	5	5	5	5	5	5	-
Stainless	Max Traction Load (N)	105	210	285	480	-	-	-	-	-
	Breaking Strength (N)	425	855	1140	1920	-	-	-	-	-
	Elongation at MTL (mm/m)	3,8	3,8	3,8	3,8	-	-	-	-	-

Average values

FLEXION RESISTANCE

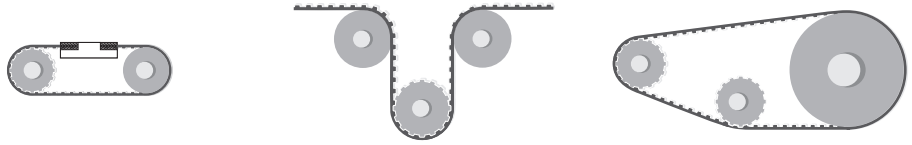

	Z_{min}	Z_{min}	Idler min dia (mm)	Z_{min}	Idler min dia (mm)
Standard steel cords	10	15	30	10	30
Kevlar cords	12	15	30	12	30
High Power cords	15	15	40	15	60
High Flexibility cords	10	12	30	10	30
Stainless steel cords	15	18	40	15	40

JOINED BELT INFORMATIONS

- Minimum splice length 900 mm
- Traction and tooth resistances = 50% less than open-end
- Joined belt can be used only in conveyor systems
- Rolls with NFT, NFB, AVAFC and APL can be joined too
- Minimum diameters according above table
- For coated belts, minimum diameters on page 118

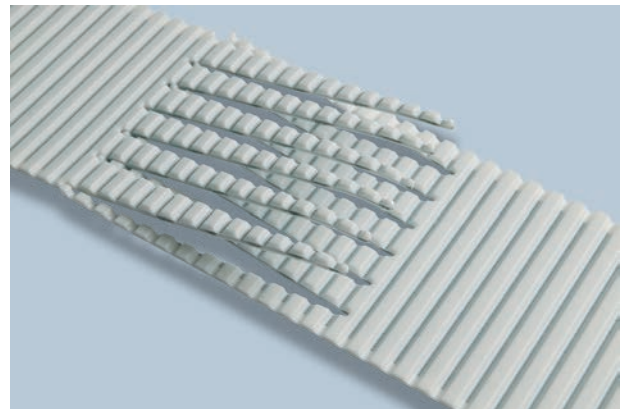

PULLEYS (for more details please see our pulleys catalogue)

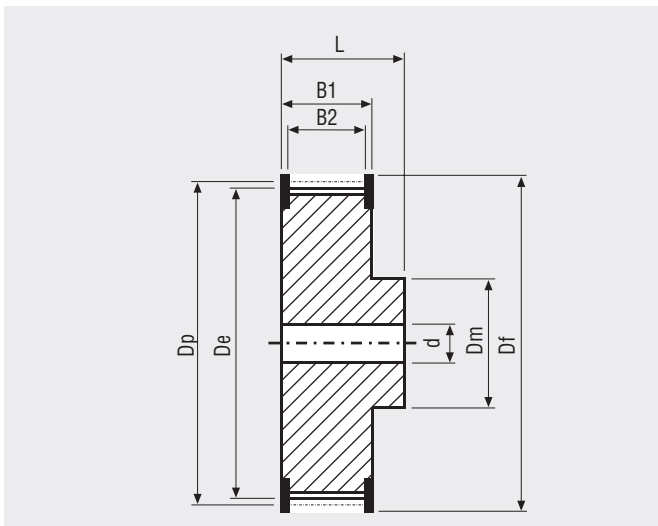

N° Teeth	Dp	De	N° Teeth	Dp	De
10	15,92	15,09	25	39,79	38,96
12	19,10	18,27	28	44,56	43,73
14	22,28	21,45	30	47,75	46,92
15	23,87	23,04	32	50,93	50,10
16	25,46	24,64	36	57,30	56,47
18	28,65	27,82	40	63,66	62,93
19	30,24	29,41	42	66,85	66,02
20	31,83	31,00	44	70,03	69,20
22	35,01	34,19	48	76,39	75,57
24	38,20	37,37	60	95,49	94,67

MEGALINEAR T5 WIDE OPEN-END

BELT CHARACTERISTICS

STANDARD WIDTHS (mm)	250	500
Weight (gr/m)	500	1000

Standard compound: **transparent Polyurethane thermoplastic 90 ShA**

Standard back cover: **none**

Standard tooth cover: **none**

Standard cords: **S and Z torsion Kevlar at pitch 3,5 mm**

Standard width tolerance: **+/- 2 mm**

Standard thickness: **2,2 +/- 0,15 mm**

Standard length tolerance: **+/- 0,8 mm/m**

Standard roll length: **100 m**

Belt options on request with minimum quantity:

- Nylon fabric back
- Nylon fabric teeth
- Transparent FDA compound

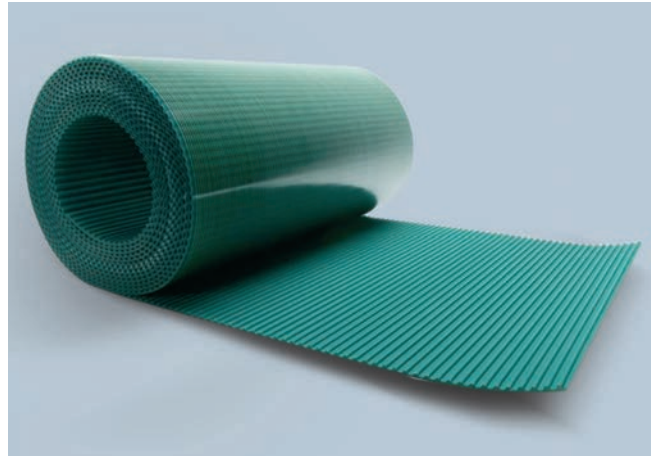

TOOTH PROFILE ACCORDING ISO 17396

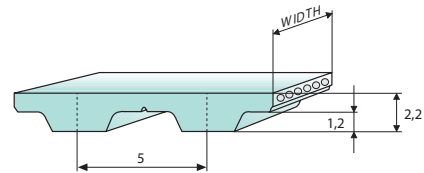

TOOTH RESISTANCE

RPM (1/min)	0	20	40	60	80	100	200	300	400	500	750	1000
F _{p spec} (N/cm)	17	16	16	15	15	15	14	13	13	12	12	11

TRACTION RESISTANCE

Belt width (mm)		250	500
Kevlar	Max Traction Load (N)	5300	10600
	Breaking Strength (N)	18550	37100
	Elongation at MTL (mm/m)	8	8

Average values

FLEXION RESISTANCE

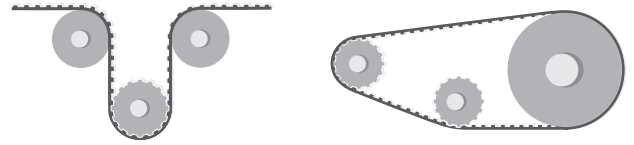

	Z_{min}	Idler min dia (mm)	Z_{min}	Idler min dia (mm)
Kevlar cords	15	45	12	45

JOINED BELT INFORMATIONS

- Traction and tooth resistances = 50% less than open-end
- Joined belt can be used only in conveyor systems
- Rolls with NFT and NFB can be joined too
- Minimum diameters according above table



PULLEYS (for more details please see our pulleys catalogue)

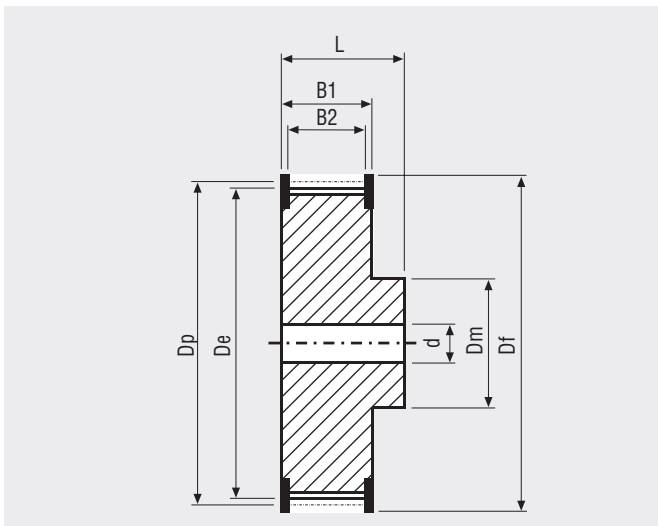

N° Teeth	Dp	De	N° Teeth	Dp	De
10	15,92	15,09	25	39,79	38,96
12	19,10	18,275	28	44,56	43,73
14	22,28	21,45	30	47,75	46,92
15	23,87	23,04	32	50,93	50,10
16	25,46	24,64	36	57,30	56,47
18	28,65	27,82	40	63,66	62,93
19	30,24	29,41	42	66,85	66,02
20	31,83	31,00	44	70,03	69,20
22	35,01	34,19	48	76,39	75,57
24	38,20	37,37	60	95,49	94,67

MEGALINEAR TT5 FOR KNITTING MACHINE

BELT CHARACTERISTICS

STANDARD WIDTHS (mm)	10
Weight (gr/m)	20

Standard compound: **white Polyurethane thermoplastic 88 ShA**
 Standard back cover: **none**
 Standard tooth cover: **none**
 Standard cords: **S and Z torsion zinked steel**
 Standard width tolerance: **+/- 0,5 mm**
 Standard thickness: **3 + 0,2/- 0,1 mm**
 Standard length tolerance: **+/- 0,8 mm/m**
 Standard roll length: **100 m**

Standard compound: **blue Polyurethane thermoplastic 88 ShA**
 Standard back cover: **none**
 Standard tooth cover: **none**
 Standard cords: **S and Z torsion kevlar**
 Standard width tolerance: **+/- 0,5 mm**
 Standard thickness: **2,8 +/- 0,15 mm**
 Standard length tolerance: **+/- 0,8 mm/m**
 Standard roll length: **100 m**

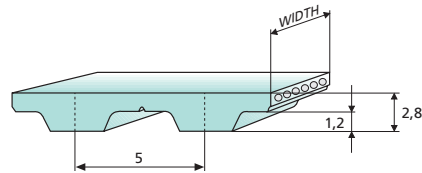
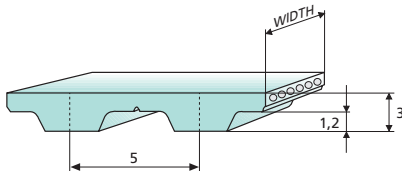
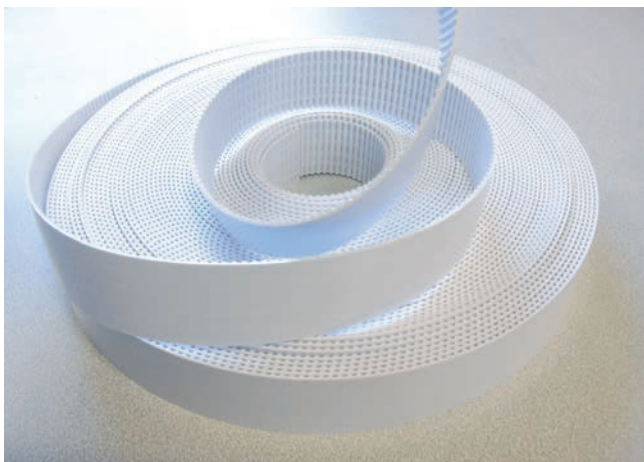

TOOTH PROFILE ACCORDING ISO 17396

TOOTH RESISTANCE

RPM (1/min)	0	20	40	60	80	100	200	300	400	500	750	1000	1500	2000	3000	4000	5000	8000
F _{p spec} (N/cm)	24	23	23	22	22	22	20	19	19	18	17	16	15	14	12	11	11	9

TRACTION RESISTANCE

Belt width (mm)	10
Steel	
Max Traction Load (N)	375
Breaking Strength (N)	1500
Elongation at MTL (mm/m)	4
Kevlar	
Max Traction Load (N)	795
Breaking Strength (N)	3190
Elongation at MTL (mm/m)	8

Average values

MEGALINEAR TT5 FOR KNITTING MACHINE

FLEXION RESISTANCE

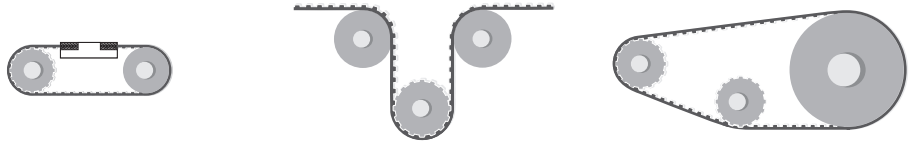

	Z_{min}	Z_{min}	Idler min dia (mm)	Z_{min}	Idler min dia (mm)
Standard steel cords	10	15	30	10	30
Kevlar cords	12	15	30	12	30

JOINED BELT INFORMATIONS

- Minimum splice length 900 mm
- Traction and tooth resistances = 50% less than open-end
- Joined belt can be used only in conveyor systems
- Rolls with NFT, and NFB can be joined too
- Minimum diameters according above table

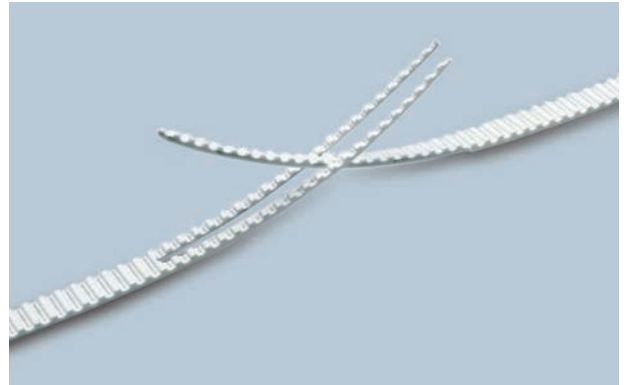

MEGALINEAR T10 OPEN-END

BELT CHARACTERISTICS

STANDARD WIDTHS (mm)	12	16	25	32	50	75	100	150
Weight (gr/m)	50	75	115	145	225	340	435	680

- Standard compound: **white Polyurethane thermoplastic 92 ShA**
- Standard back cover: **none**
- Standard tooth cover: **none**
- Standard cords: **S and Z torsion zinked steel**
- Standard width tolerance: **+/- 0,5 mm**
- Standard thickness: **4,5 +/- 0,3 mm**
- Standard length tolerance: **+/- 0,8 mm/m**
- Standard roll length: **100 m**
- Belt options on request with minimum quantity:
- Nylon fabric back
 - Nylon fabric teeth
 - Antistatic nylon fabric
 - Transparent FDA compound
 - AVAFC 60/70/85 ShA
 - APL
 - Fishbone
 - Ribbed
 - SUPERGRIP PVC
 - Cleats

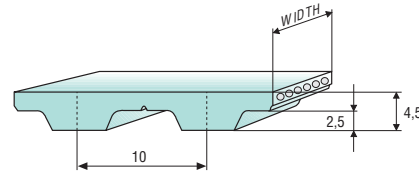
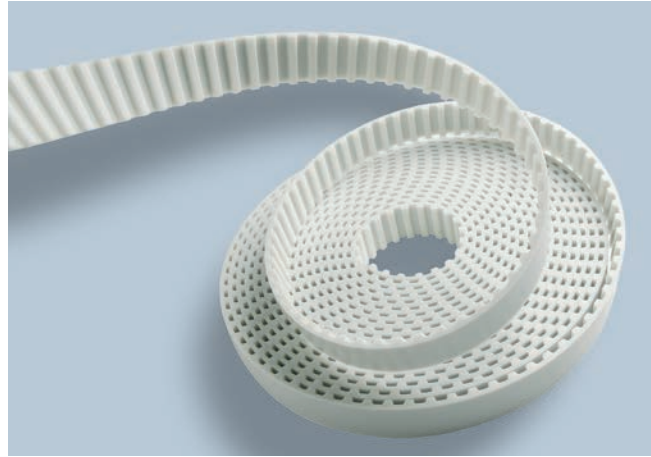

Different back coating materials see page 118

TOOTH PROFILE ACCORDING ISO 17396

TOOTH RESISTANCE

RPM (1/min)	0	20	40	60	80	100	200	300	400	500	750	1000	1500	2000	3000	4000	5000	8000
F _{p spec} (N/cm)	51	49	48	47	46	45	41	39	37	36	33	31	28	25	22	20	18	14

Minimum suggested number of teeth in clamp for linear movement: 7

TRACTION RESISTANCE

Belt width (mm)		12	16	25	32	50	75	100	150
Steel	Max Traction Load (N)	1050	1470	2410	3045	5040	8065	10830	12480
	Breaking Strength (N)	4200	5880	9660	12180	20160	30660	41160	43680
	Elongation at MTL (mm/m)	4	4	4	4	4	4	4	4
Kevlar	Max Traction Load (N)	895	1150	2050	2565	4360	7020	9450	15240
	Breaking Strength (N)	3590	4615	8205	10260	17440	26675	35910	53350
	Elongation at MTL (mm/m)	8	8	8	8	8	8	8	8
HP	Max Traction Load (N)	1660	2135	3800	4750	8075	13000	17500	28225
	Breaking Strength (N)	6650	8550	15200	19000	32300	49400	66500	98800
	Elongation at MTL (mm/m)	4	4	4	4	4	4	4	4
HF	Max Traction Load (N)	1100	1540	2530	3190	5280	8450	11345	13070
	Breaking Strength (N)	4400	6160	10120	12760	21120	32120	43120	45760
	Elongation at MTL (mm/m)	5	5	5	5	5	5	5	5
HPF	Max Traction Load (N)	-	2385	4240	5300	9010	14505	19525	31495
	Breaking Strength (N)	-	9540	16960	21200	36040	55120	74200	110240
	Elongation at MTL (mm/m)	5	5	5	5	5	5	5	5
Stainless	Max Traction Load (N)	805	1130	1855	2340	3875	-	-	-
	Breaking Strength (N)	3230	4520	7425	9365	15500	-	-	-
	Elongation at MTL (mm/m)	3,8	3,8	3,8	3,8	3,8	-	-	-

Average values

FLEXION RESISTANCE

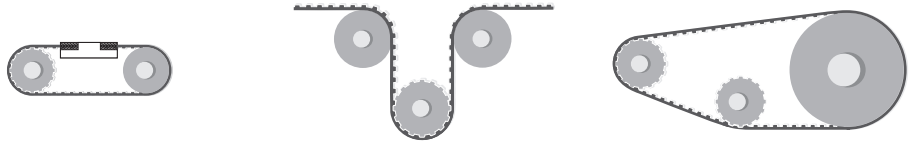

	Z_{min}	Z_{min}	Idler min dia (mm)	Z_{min}	Idler min dia (mm)
Standard steel cords	12	20	60	12	60
Kevlar cords	15	20	60	15	60
High Power cords	15	20	100	15	100
High Flexibility cords	12	15	50	12	50
High Power Flexible cords	14	20	80	14	80
Stainless steel cords	15	20	70	15	70

JOINED BELT INFORMATIONS

- Minimum splice length 900 mm
- Traction and tooth resistances = 50% less than open-end
- Joined belt can be used only in conveyor systems
- Rolls with NFT, NFB, AVAFC and APL can be joined too
- Minimum diameters according above table
- For coated belts, minimum diameters on page 118

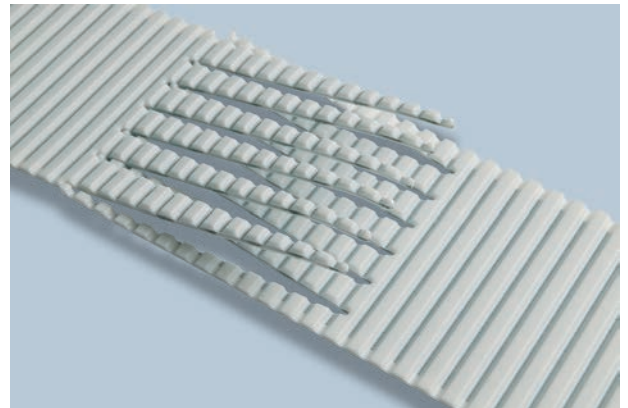

PULLEYS (for more details please see our pulleys catalogue)

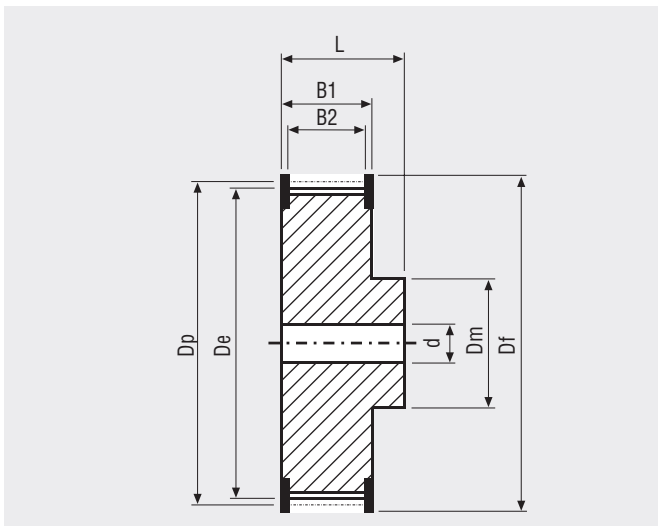

N° Teeth	Dp	De	N° Teeth	Dp	De
12	38,20	36,35	26	82,76	80,91
14	44,56	42,71	27	85,94	84,10
15	47,75	45,90	28	89,13	87,28
16	50,93	49,08	30	95,49	93,65
18	57,30	55,45	32	101,86	100,01
19	60,48	58,63	36	114,59	112,74
20	63,66	61,81	40	127,32	125,48
22	70,03	68,18	44	140,06	138,21
24	76,39	74,55	48	152,79	150,94
25	79,58	77,73	60	190,99	189,14

MEGALINEAR T10 WITHOUT GAP OPEN-END

BELT CHARACTERISTICS

STANDARD WIDTHS (mm)	16	25	32	50	75
Weight (gr/m)	74	115	148	230	345

Standard compound: **white Polyurethane thermoplastic 92 ShA**
 Standard back cover: **none**
 Standard tooth cover: **none**
 Standard cords: **S and Z torsion zinked steel**
 Standard width tolerance: **+/- 0,5 mm**
 Standard thickness: **4,5 +/- 0,3 mm**
 Standard length tolerance: **+/- 0,8 mm/m**
 Standard roll length: **100 m**

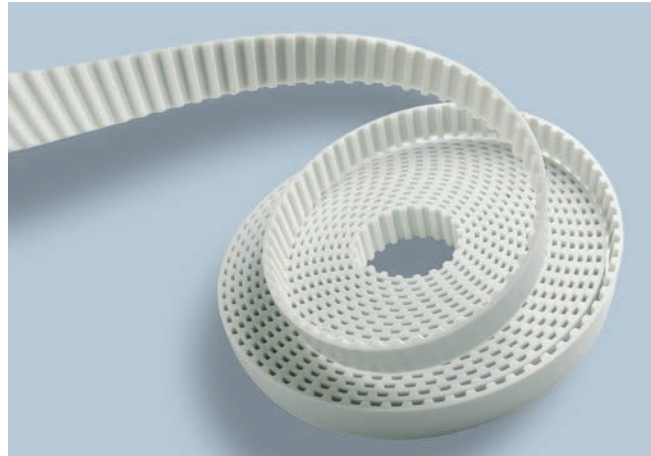

TOOTH PROFILE ACCORDING ISO 17396

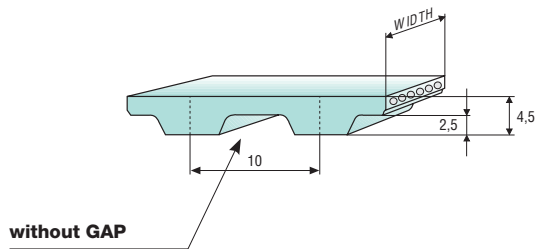

TOOTH RESISTANCE

RPM (1/min)	0	20	40	60	80	100	200	300	400	500	750	1000	1500	2000	3000	4000	5000	8000
$F_{p\ spec}$ (N/cm)	51	49	48	47	46	45	41	39	37	36	33	31	28	25	22	20	18	14

Minimum suggested number of teeth in clamp for linear movement: 7

TRACTION RESISTANCE

Belt width (mm)		16	25	32	50	75
Steel	Max Traction Load (N)	1365	2310	2940	4830	7955
	Breaking Strength (N)	5460	9240	11760	19320	30240
	Elongation at MTL (mm/m)	4	4	4	4	4
Kevlar	Max Traction Load (N)	1665	2820	3330	5640	8910
	Breaking Strength (N)	6665	11285	13335	22570	33855
	Elongation at MTL (mm/m)	8	8	8	8	8

Average values

MEGALINEAR T10 WITHOUT GAP OPEN-END

FLEXION RESISTANCE

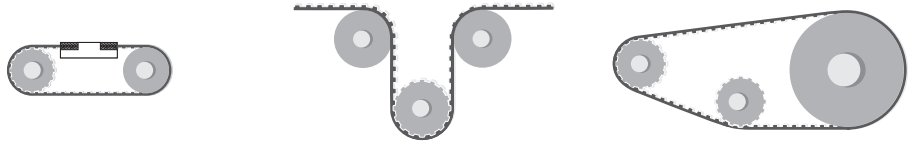

	Z_{min}	Z_{min}	Idler min dia (mm)	Z_{min}	Idler min dia (mm)
Standard steel cords	12	20	60	12	60
Kevlar cords	15	20	60	15	60

TYPICAL APPLICATION - CAR WASHING MACHINE



PULLEYS (for more details please see our pulleys catalogue)

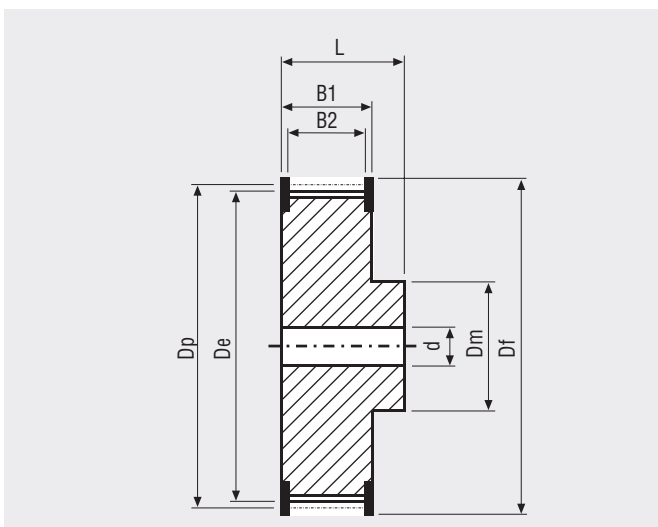

N° Teeth	Dp	De	N° Teeth	Dp	De
12	38,20	36,35	26	82,76	80,91
14	44,56	42,71	27	85,94	84,10
15	47,75	45,90	28	89,13	87,28
16	50,93	49,08	30	95,49	93,65
18	57,30	55,45	32	101,86	100,01
19	60,48	58,63	36	114,59	112,74
20	63,66	61,81	40	127,32	125,48
22	70,03	68,18	44	140,06	138,21
24	76,39	74,55	48	152,79	150,94
25	79,58	77,73	60	190,99	189,14

MEGALINEAR T10 WIDE OPEN-END

BELT CHARACTERISTICS

STANDARD WIDTHS (mm)	200	250	300	400	450	500
Weight (gr/m)	410	510	615	820	920	1020

Standard compound: **transparent Polyurethane thermoplastic 90 ShA**

Standard back cover: **none**

Standard tooth cover: **none**

Standard cords: **S and Z torsion Kevlar at pitch 3,5 mm**

Standard width tolerance: **+/- 2 mm**

Standard thickness: **4,5 +/- 0,3 mm**

Standard length tolerance: **+/- 0,8 mm/m**

Standard roll length: **100 m**

Belt options on request with minimum quantity:

- Nylon fabric back
- Nylon fabric teeth
- Antistatic Nylon fabric
- Transparent FDA compound

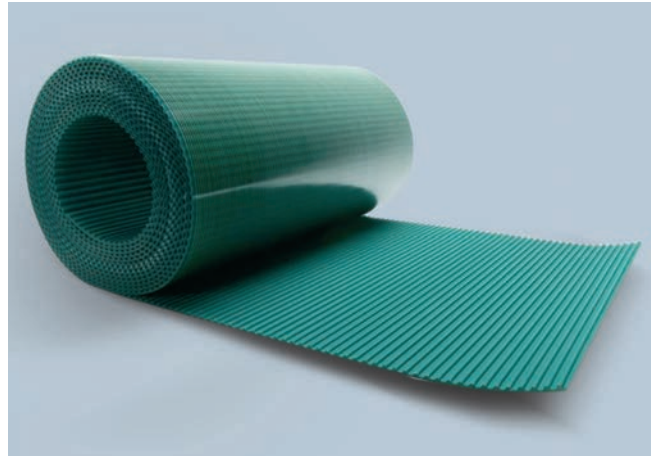

TOOTH PROFILE ACCORDING ISO 17396

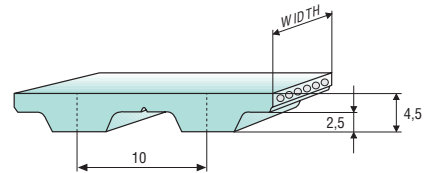

TOOTH RESISTANCE

RPM (1/min)	0	20	40	60	80	100	200	300	400	500	750	1000
$F_{p\ spec}$ (N/cm)	36	34	34	33	32	31	29	27	26	25	23	22

TRACTION RESISTANCE

Belt width (mm)		200	250	300	400	450	500
Kevlar	Max Traction Load (N)	8350	10255	12310	16560	18610	20810
	Breaking Strength (N)	29240	35905	43090	57965	65150	72845
	Elongation at MTL (mm/m)	8	8	8	8	8	8

Average values

FLEXION RESISTANCE

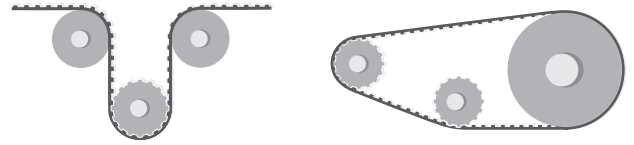

	Z_{min}	Idler min dia (mm)	Z_{min}	Idler min dia (mm)
Kevlar cords	20	60	15	60

JOINED BELT INFORMATIONS

- Traction and tooth resistances = 50% less than open-end
- Joined belt can be used only in conveyor systems
- Rolls with NFT and NFB can be joined too
- Minimum diameters according above table



PULLEYS (for more details please see our pulleys catalogue)

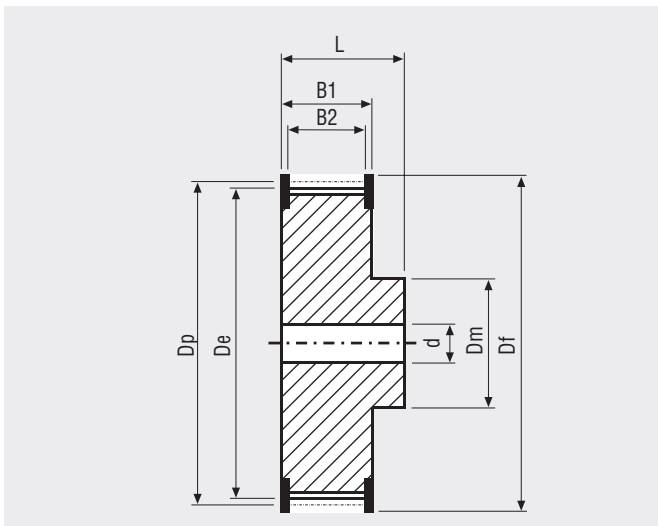

N° Teeth	Dp	De	N° Teeth	Dp	De
12	38,20	36,35	26	82,76	80,91
14	44,56	42,71	27	85,94	84,10
15	47,75	45,90	28	89,13	87,28
16	50,93	49,08	30	95,49	93,65
18	57,30	55,45	32	101,86	100,01
19	60,48	58,63	36	114,59	112,74
20	63,66	61,81	40	127,32	125,48
22	70,03	68,18	44	140,06	138,21
24	76,39	74,55	48	152,79	150,94
25	79,58	77,73	60	190,99	189,14

MEGALINEAR T20 OPEN-END

BELT CHARACTERISTICS

STANDARD WIDTHS (mm)	25	32	50	75	100	150
Weight (gr/m)	185	235	370	550	735	1095

Standard compound: **white Polyurethane thermoplastic 92 ShA**

Standard back cover: **none**

Standard tooth cover: **none**

Standard cords: **S and Z torsion zinked steel**

Standard width tolerance: **+/- 1 mm**

Standard thickness: **8 +/- 0,45 mm**

Standard length tolerance: **+/- 0,8 mm/m**

Standard roll length: **100 m**

Belt options on request with minimum quantity:

- Nylon fabric back
- Nylon fabric teeth
- Antistatic nylon fabric
- Transparent FDA compound
- AVAFC 60/70/85 ShA
- APL
- Fishbone
- Ribbed
- Cleats

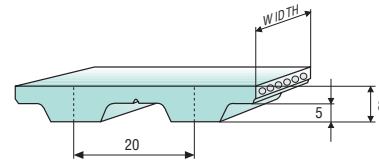
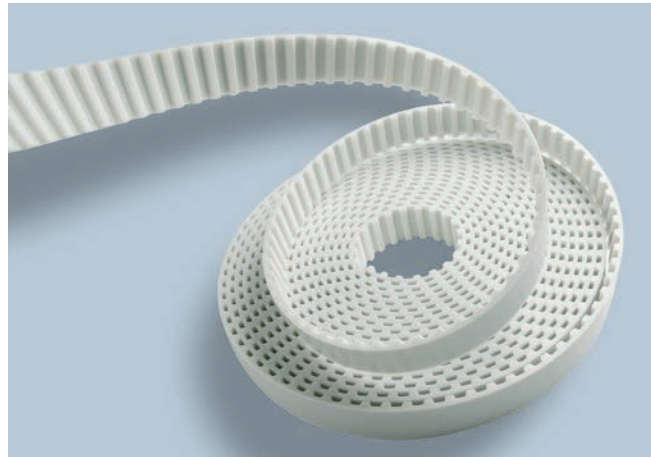

Different back coating materials see page 118

TOOTH PROFILE ACCORDING ISO 17396

TOOTH RESISTANCE

RPM (1/min)	0	20	40	60	80	100	200	300	400	500	750	1000	1500	2000	3000	4000	5000
F _{p spec} (N/cm)	102	98	95	93	91	89	81	76	72	68	62	57	50	45	38	33	29

Minimum suggested number of teeth in clamp for linear movement: 7

TRACTION RESISTANCE

Belt width (mm)		25	32	50	75	100	150
Steel	Max Traction Load (N)	3800	4750	8075	13000	17500	28225
	Breaking Strength (N)	15200	19000	32300	49400	66500	98800
	Elongation at MTL (mm/m)	4	4	4	4	4	4
Kevlar	Max Traction Load (N)	4215	5620	9135	14800	19975	32940
	Breaking Strength (N)	16870	22495	36555	56240	75920	115290
	Elongation at MTL (mm/m)	8	8	8	8	8	8
HP	Max Traction Load (N)	5190	6920	11245	18210	24580	40530
	Breaking Strength (N)	20760	27680	44980	69200	93420	141860
	Elongation at MTL (mm/m)	4	4	4	4	4	4
HF	Max Traction Load (N)	4240	5300	9090	14505	-	-
	Breaking Strength (N)	16960	21200	36040	55120	-	-
	Elongation at MTL (mm/m)	5	5	5	5	-	-
HPF	Max Traction Load (N)	5775	7700	12510	20260	-	-
	Breaking Strength (N)	23100	30800	50050	77000	-	-
	Elongation at MTL (mm/m)	5	5	5	5	-	-
Stainless	Max Traction Load (N)	2865	3585	6095	-	-	-
	Breaking Strength (N)	11475	14345	24385	-	-	-
	Elongation at MTL (mm/m)	3,8	3,8	3,8	-	-	-

Average values

FLEXION RESISTANCE

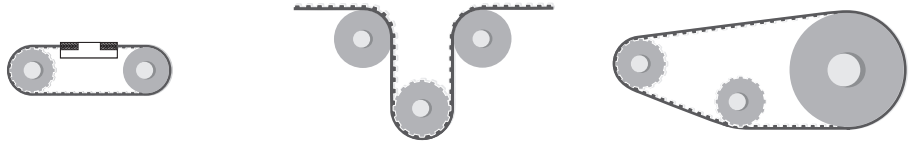

	Z_{min}	Z_{min}	Idler min dia (mm)	Z_{min}	Idler min dia (mm)
Standard steel cords	15	25	120	15	120
Kevlar cords	15	25	120	15	120
High Power cords	20	25	150	20	150
High Flexibility cords	15	20	120	15	120
High Power Flexible cords	18	25	120	18	120
Stainless steel cords	20	25	130	20	130

JOINED BELT INFORMATIONS

- Minimum splice length 900 mm
- Traction and tooth resistances = 50% less than open-end
- Joined belt can be used only in conveyor systems
- Rolls with NFT, NFB, AVAFC and APL can be joined too
- Minimum diameters according above table
- For coated belts, minimum diameters on page 118

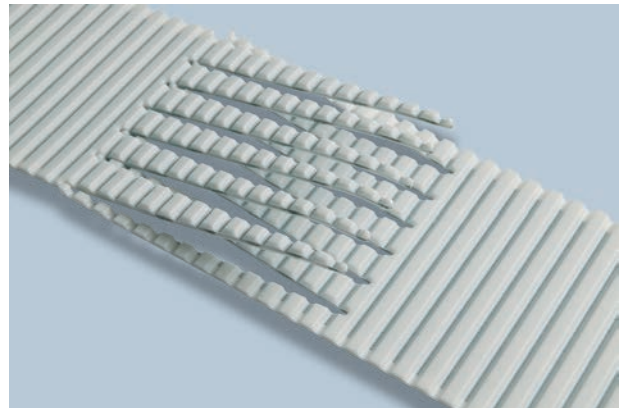

PULLEYS (for more details please see our pulleys catalogue)

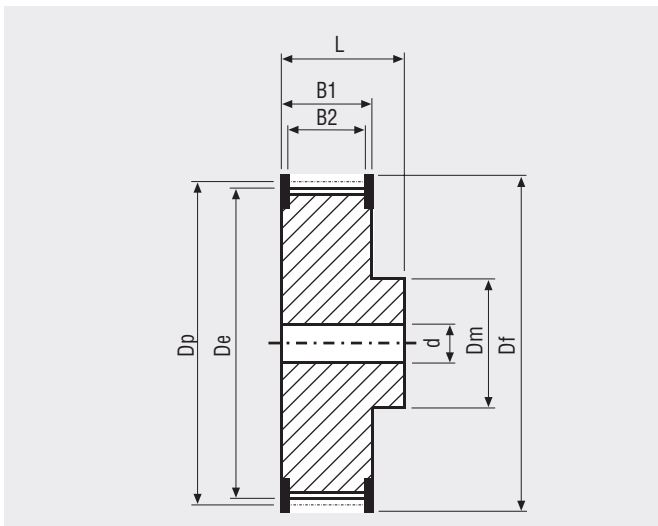

N° Teeth	Dp	De	N° Teeth	Dp	De
15	95,54	92,69	30	190,99	188,13
18	114,59	111,73	32	203,72	200,86
20	127,32	124,47	36	229,18	226,33
22	140,06	137,20	40	254,65	251,80
24	152,79	149,93	48	305,58	302,73
25	159,15	156,30	60	381,97	379,12

MEGALINEAR AT3 OPEN-END

BELT CHARACTERISTICS

STANDARD WIDTHS (mm)	10	20	25	50
Weight (gr/m)	20	45	60	115

Standard compound: **white Polyurethane thermoplastic 92 ShA**

Standard back cover: **none**

Standard tooth cover: **none**

Standard cords: **S and Z torsion zinked steel**

Standard width tolerance: **+/- 0,5 mm**

Standard thickness: **1,9 +/- 0,1 mm**

Standard length tolerance: **+/- 0,5 mm/m**

Standard roll length: **100 m**

Belt options on request with minimum quantity:

- Nylon fabric back
- Nylon fabric teeth
- Antistatic nylon fabric

Different back coating materials see page 118

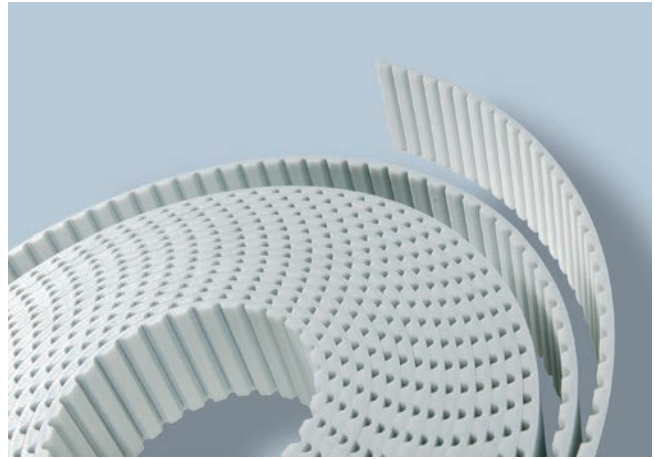

TOOTH PROFILE ACCORDING ISO 17396

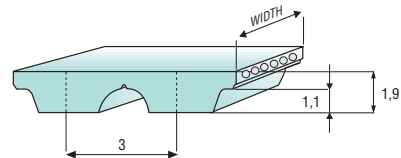

TOOTH RESISTANCE

RPM (1/min)	0	20	40	60	80	100	200	300	400	500	750	1000	1500	2000	3000	4000	5000	8000
F _{p spec} (N/cm)	24	24	24	23	23	23	22	21	21	20	19	18	16	15	14	13	12	10

Minimum suggested number of teeth in clamp for linear movement: 7

TRACTION RESISTANCE

Belt width (mm)		10	20	25	50
Steel	Max Traction Load (N)	410	820	1065	2170
	Breaking Strength (N)	1640	3280	4260	8690
	Elongation at MTL (mm/m)	4	4	4	4

Average values

FLEXION RESISTANCE



	Z_{min}	Z_{min}	Idler min dia (mm)	Z_{min}	Idler min dia (mm)
Standard steel cords	20	25	30	20	30

JOINED BELT INFORMATIONS

- Minimum splice length 900 mm
- Traction and tooth resistances = 50% less than open-end
- Joined belt can be used only in conveyor systems
- Rolls with NFT and NFB can be joined too
- Minimum diameters according above table
- For coated belts, minimum diameters on page 118

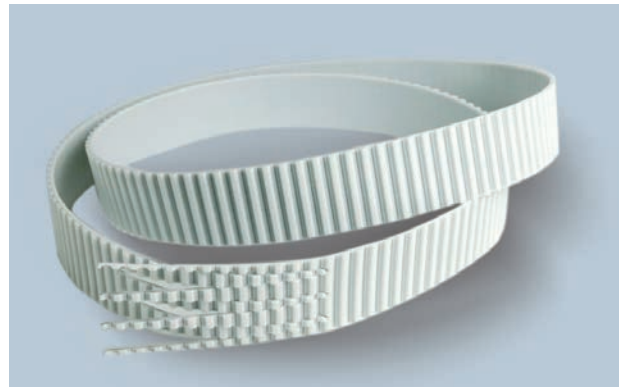

PULLEYS (for more details please see our pulleys catalogue)

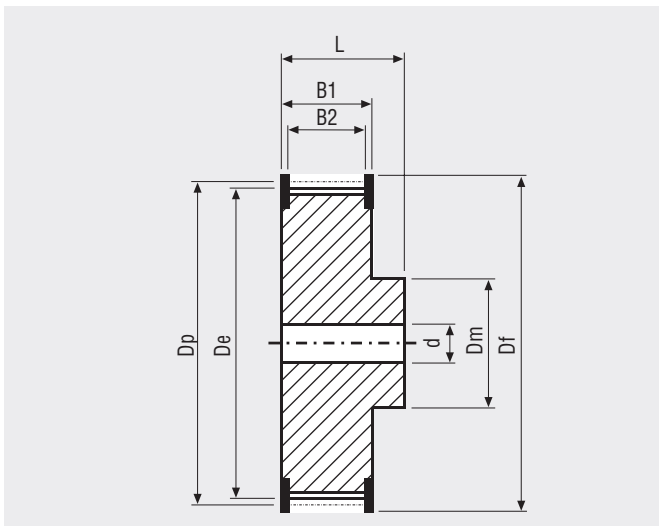

N° Teeth	Dp	De	N° Teeth	Dp	De
20	19,10	18,69	36	34,39	33,97
22	21,01	20,6	40	38,21	37,79
24	22,92	22,51	44	42,03	41,61
25	23,88	23,46	45	42,99	42,56
27	25,79	25,37	48	45,85	45,43
30	28,66	28,24	60	57,32	58,69
32	30,57	30,15	72	68,78	68,34

MEGALINEAR AT5 OPEN-END

BELT CHARACTERISTICS

STANDARD WIDTHS (mm)	6	10	16	25	32	50	75	100
Weight (gr/m)	20	35	50	80	105	165	245	340

- Standard compound: **white Polyurethane thermoplastic 92 ShA**
- Standard back cover: **none**
- Standard tooth cover: **none**
- Standard cords: **S and Z torsion zinked steel**
- Standard width tolerance: **+/- 0,5 mm**
- Standard thickness: **2,7 +/- 0,2 mm**
- Standard length tolerance: **+/- 0,8 mm/m**
- HP+HPF cord lenght tolerance: **+0/- 0,8 mm/m**
- Standard roll length: **100 m**
- Belt options on request with minimum quantity:
 - Nylon fabric back
 - Nylon fabric teeth
 - Antistatic nylon fabric
 - Transparent FDA compound
 - AVAFC 60/70/85 ShA
 - APL
 - Cleats

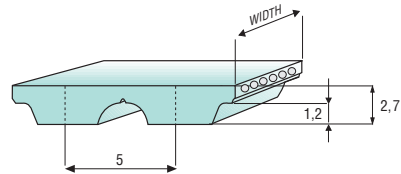
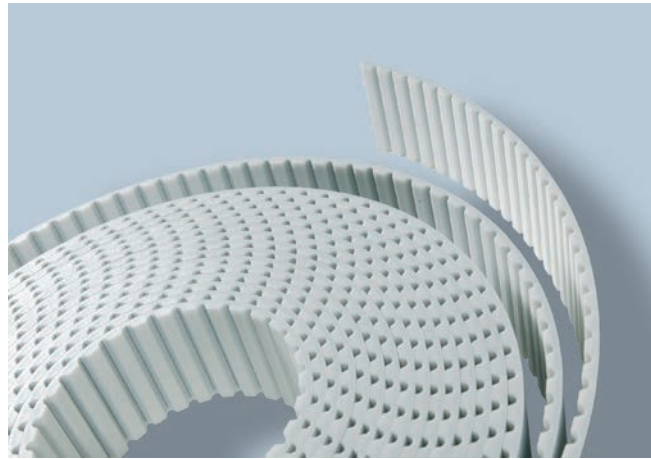

Different back coating materials see page 118

TOOTH PROFILE ACCORDING ISO 17396

TOOTH RESISTANCE

RPM (1/min)	0	20	40	60	80	100	200	300	400	500	750	1000	1500	2000	3000	4000	5000	8000
F _{p spec} (N/cm)	35	35	35	34	34	34	32	31	30	29	27	26	24	22	19	18	16	13

Minimum suggested number of teeth in clamp for linear movement: 7 - HP/HPF cords minimum suggested number of teeth in clamp 10

TRACTION RESISTANCE

Belt width (mm)		6	10	16	25	32	50	75	100
Steel	Max Traction Load (N)	400	670	1070	1805	2275	3750	5145	6910
	Breaking Strength (N)	1605	2680	4285	7235	9110	15005	19560	26260
	Elongation at MTL (mm/m)	4	4	4	4	4	4	4	4
Kevlar	Max Traction Load (N)	395	665	1060	1795	2260	3720	5110	6860
	Breaking Strength (N)	1595	2660	4255	7180	9040	14895	19415	26065
	Elongation at MTL (mm/m)	8	8	8	8	8	8	8	8
HP	Max Traction Load (N)	-	840	1470	2415	3045	5040	-	-
	Breaking Strength (N)	-	3360	5880	9660	12180	20160	-	-
	Elongation at MTL (mm/m)	-	4	4	4	4	4	-	-
HF	Max Traction Load (N)	-	685	1100	1855	2335	3850	-	-
	Breaking Strength (N)	-	2750	4400	7425	9350	15400	-	-
	Elongation at MTL (mm/m)	-	5	5	5	5	5	-	-
HPF	Max Traction Load (N)	-	880	1540	2530	3190	5280	-	-
	Breaking Strength (N)	-	3520	6160	10120	12760	21120	-	-
	Elongation at MTL (mm/m)	-	5	5	5	5	5	-	-
Stainless	Max Traction Load (N)	310	520	835	1410	-	-	-	-
	Breaking Strength (N)	1250	2090	3340	5640	-	-	-	-
	Elongation at MTL (mm/m)	3,8	3,8	3,8	3,8	-	-	-	-

Average values

FLEXION RESISTANCE

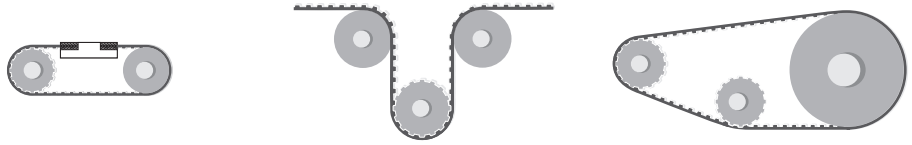

	Z_{min}	Z_{min}	Idler min dia (mm)	Z_{min}	Idler min dia (mm)
Standard steel cords	15	15	60	15	25
Kevlar cords	15	25	60	15	25
High Power cords	25	25	60	25	40
High Flexibility cords	12	13	40	12	25
High Power Flexible cords	20	24	40	20	40
Stainless steel cords	15	18	65	15	60

JOINED BELT INFORMATIONS

- Minimum splice length 900 mm
- Traction and tooth resistances = 50% less than open-end
- Joined belt can be used only in conveyor systems
- Rolls with NFT, NFB, AVAFC and APL can be joined too
- Minimum diameters according above table
- For coated belts, minimum diameters on page 118



PULLEYS (for more details please see our pulleys catalogue)

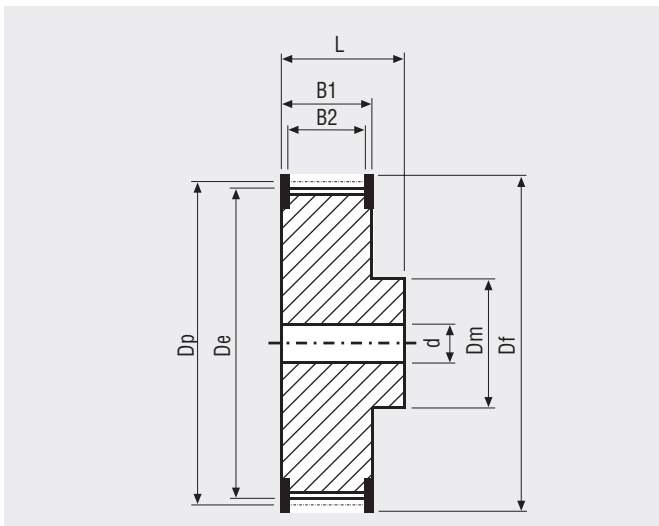

N° Teeth	Dp	De	N° Teeth	Dp	De
15	23,87	22,64	28	44,56	43,33
16	25,46	24,24	30	47,75	46,52
18	28,65	27,42	32	50,93	49,70
19	30,24	29,01	36	57,30	56,07
20	31,83	30,60	40	63,66	62,43
22	35,01	33,79	42	66,85	65,62
24	38,20	36,97	44	70,03	68,80
25	39,79	38,56	48	76,39	75,17
26	41,38	40,15	60	95,49	94,27
27	42,97	41,74			

MEGALINEAR AT10 OPEN-END

BELT CHARACTERISTICS

STANDARD WIDTHS (mm)	16	25	32	50	75	100	150
Weight (gr/m)	90	160	185	290	435	580	890

- Standard compound: **white Polyurethane thermoplastic 92 ShA**
- Standard back cover: **none**
- Standard tooth cover: **none**
- Standard cords: **S and Z torsion zinked steel**
- Standard width tolerance: **+/- 0,5 mm**
- Standard thickness: **4,5 +/- 0,3 mm**
- Standard length tolerance: **+/- 0,8 mm/m**
- HP+HPF cord length tolerance: **+0/- 0,8 mm/m**
- Standard roll length: **100 m**
- Belt options on request with minimum quantity:
- Nylon fabric back
 - Nylon fabric teeth
 - Antistatic nylon fabric
 - Transparent FDA compound
 - AVAFC 60/70/85 ShA
 - APL
 - Fishbone
 - Ribbed
 - Cleats

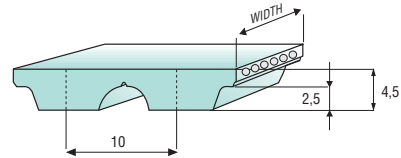
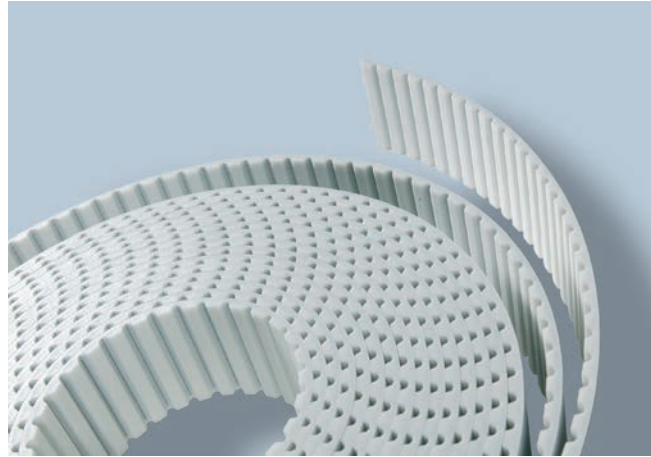

Different back coating materials see page 118
TOOTH PROFILE ACCORDING ISO 17396

TOOTH RESISTANCE

RPM (1/min)	0	20	40	60	80	100	200	300	400	500	750	1000	1500	2000	3000	4000	5000	8000
F _{p spec} (N/cm)	83	80	80	80	78	77	73	69	67	65	58	55	48	44	38	33	30	22

Minimum suggested number of teeth in clamp for linear movement: 7 - HP/HPF cords minimum suggested number of teeth in clamp 10

TRACTION RESISTANCE

Belt width (mm)		16	25	32	50	75	100	150
Steel	Max Traction Load (N)	2270	4000	5160	8590	13800	18600	30600
	Breaking Strength (N)	9100	16100	20200	34300	52500	70700	105000
	Elongation at MTL (mm/m)	4	4	4	4	4	4	4
Kevlar	Max Traction Load (N)	2105	4215	5620	9135	14800	19980	32940
	Breaking Strength (N)	8435	16870	22495	36555	56240	75920	115290
	Elongation at MTL (mm/m)	8	8	8	8	8	8	8
HP	Max Traction Load (N)	3460	5190	6920	11245	18210	24580	40530
	Breaking Strength (N)	13840	20760	27680	44980	69200	93420	141860
	Elongation at MTL (mm/m)	4	4	4	4	4	4	4
HF	Max Traction Load (N)	2385	4240	5300	9010	14505	19525	31495
	Breaking Strength (N)	9540	16960	21200	36040	55120	74200	110240
	Elongation at MTL (mm/m)	5	5	5 b	5	5	5	5
HPF	Max Traction Load (N)	3850	5775	7700	12510	20260	27355	45100
	Breaking Strength (N)	15400	23100	30800	50050	77000	103950	157850
	Elongation at MTL (mm/m)	5	5	5	5	5	5	5
Stainless	Max Traction Load (N)	1610	2865	3585	6095	-	-	-
	Breaking Strength (N)	6455	11475	14345	24385	-	-	-
	Elongation at MTL (mm/m)	3,8	3,8	3,8	3,8	-	-	-

Average values

FLEXION RESISTANCE

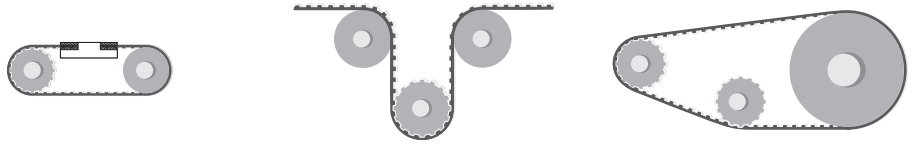

	Z_{min}	Z_{min}	Idler min dia (mm)	Z_{min}	Idler min dia (mm)
Standard steel cords	15	20	120	15	50
Kevlar cords	15	20	120	15	50
High Power cords	25	25	150	25	80
High Flexibility cords	15	20	80	15	50
High Power Flexible cords	16	20	100	16	60
Stainless steel cords	19	25	110	19	110

JOINED BELT INFORMATIONS

- Minimum splice length 900 mm
- Traction and tooth resistances = 50% less than open-end
- Joined belt can be used only in conveyor systems
- Rolls with NFT, NFB, AVAFC and APL can be joined too
- Minimum diameters according above table
- For coated belts, minimum diameters on page 118



PULLEYS (for more details please see our pulleys catalogue)

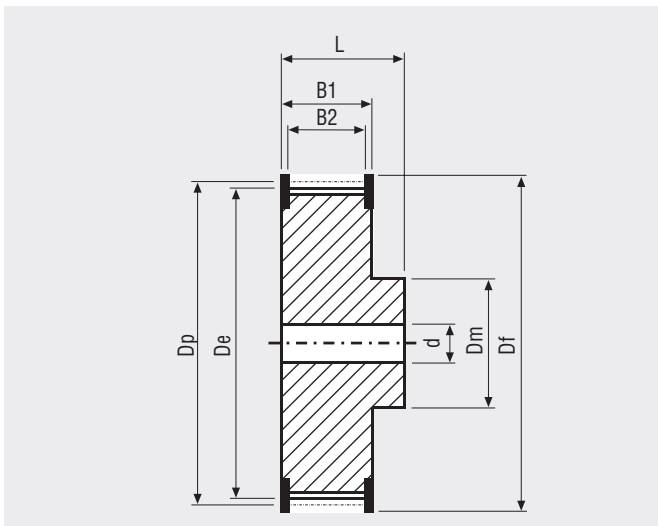

N° Teeth	Dp	De	N° Teeth	Dp	De
15	47,75	45,90	27	85,94	84,10
16	50,93	49,08	28	89,13	87,28
18	57,30	55,45	30	95,49	93,65
19	60,48	58,63	32	101,86	100,01
20	63,66	61,81	36	114,59	112,74
22	70,03	68,18	40	127,32	125,48
24	76,39	74,55	44	140,06	138,21
25	79,58	77,73	48	152,79	150,94
26	82,76	80,91	60	190,99	189,14

MEGALINEAR AT10 WITHOUT GAP OPEN-END

BELT CHARACTERISTICS

STANDARD WIDTHS (mm)	25	32	50	75	100
Weight (gr/m)	160	205	320	480	640

Standard compound: **white Polyurethane thermoplastic 92 ShA**
 Standard back cover: **none**
 Standard tooth cover: **none**
 Standard cords: **S and Z torsion zinked steel**
 Standard width tolerance: **+/- 0,5 mm**
 Standard thickness: **4,5 +/- 0,3 mm**
 Standard length tolerance: **+/- 0,8 mm/m**
 Standard roll length: **100 m**

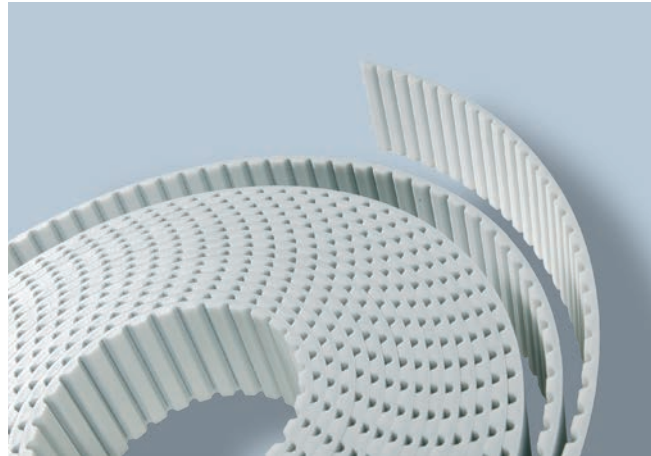

TOOTH PROFILE ACCORDING ISO 17396

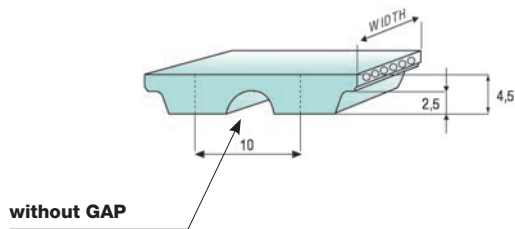

TOOTH RESISTANCE

RPM (1/min)	0	20	40	60	80	100	200	300	400	500	750	1000	1500	2000	3000	4000	5000	8000
F _{p spec} (N/cm)	74	72	71	71	70	69	65	62	60	58	53	50	44	40	35	30	27	20

Minimum suggested number of teeth in clamp for linear movement: 7

TRACTION RESISTANCE

Belt width (mm)		25	32	50	75	100
Steel	Max Traction Load (N)	3560	4510	7835	12750	17250
	Breaking Strength (N)	14250	18050	31350	48450	65550
	Elongation at MTL (mm/m)	4	4	4	4	4

Average values

MEGALINEAR AT10 WITHOUT GAP OPEN-END

FLEXION RESISTANCE

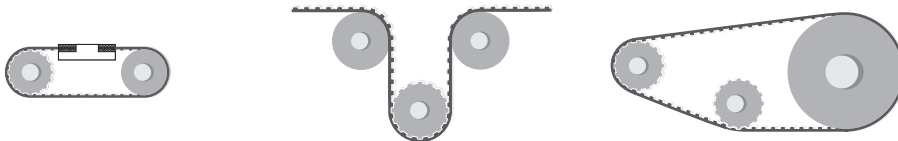

	Z_{min}	Z_{min}	Idler min dia (mm)	Z_{min}	Idler min dia (mm)
Standard steel cords	15	20	120	15	50

TYPICAL APPLICATION - CAR WASHING MACHINE



PULLEYS (for more details please see our pulleys catalogue)

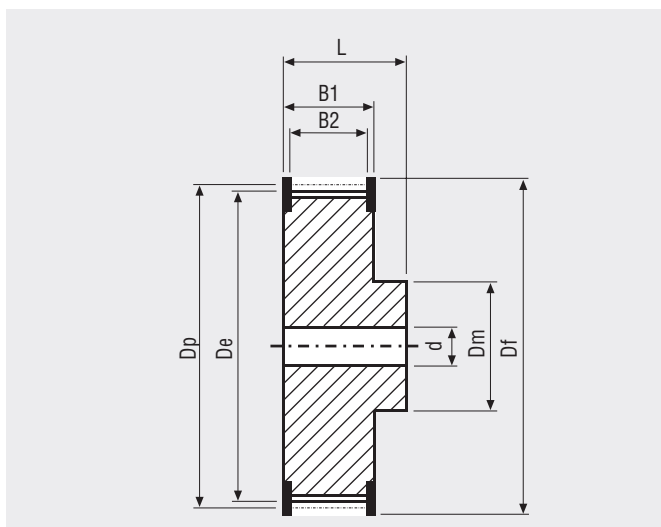

N° Teeth	Dp	De	N° Teeth	Dp	De
15	47,75	45,90	27	85,94	84,10
16	50,93	49,08	28	89,13	87,28
18	57,30	55,45	30	95,49	93,65
19	60,48	58,63	32	101,86	100,01
20	63,66	61,81	36	114,59	112,74
22	70,03	68,18	40	127,32	125,48
24	76,39	74,55	44	140,06	138,21
25	79,58	77,73	48	152,79	150,94
26	82,76	80,91	60	190,99	189,14

MEGALINEAR AT20 OPEN-END

BELT CHARACTERISTICS

STANDARD WIDTHS (mm)	25	32	50	75	100	150	200
Weight (gr/m)	225	310	480	720	960	1425	1935

- Standard compound: **white Polyurethane thermoplastic 92 ShA**
- Standard back cover: **none**
- Standard tooth cover: **none**
- Standard cords: **S and Z torsion zinked steel**
- Standard width tolerance: **+/- 1 mm**
- Standard thickness: **8 +/- 0,45 mm**
- Standard length tolerance: **+/- 0,8 mm/m**
- HP+HPF cord length tolerance: **+0/- 0,8 mm/m**
- Standard roll length: **100 m**
- Belt options on request with minimum quantity:
 - Nylon fabric back
 - Nylon fabric teeth
 - Antistatic nylon fabric
 - Transparent FDA compound
 - AVAFC 60/70/85 ShA
 - APL
 - Fishbone
 - Ribbed
 - Cleats

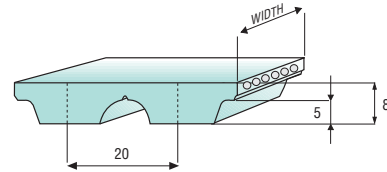
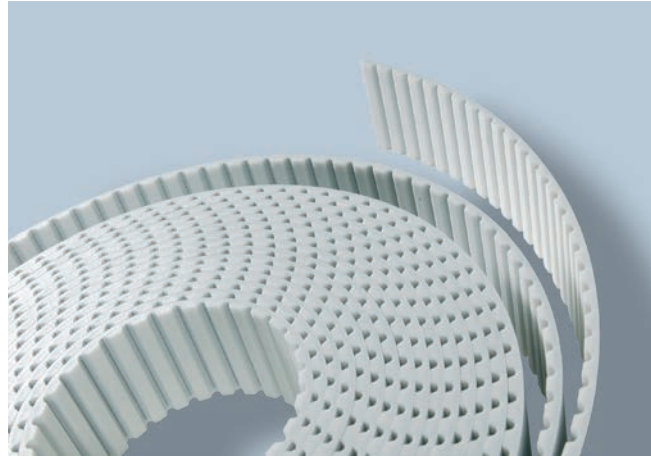

Different back coating materials see page 118

TOOTH PROFILE ACCORDING ISO 17396

TOOTH RESISTANCE

RPM (1/min)	0	20	40	60	80	100	200	300	400	500	750	1000	1500	2000	3000	4000	5000
F _{p spec} (N/cm)	147	144	142	139	137	135	126	119	112	107	97	88	76	67	58	43	35

Minimum suggested number of teeth in clamp for linear movement: 7

TRACTION RESISTANCE

Belt width (mm)		25	32	50	75	100	150	200
Steel	Max Traction Load (N)	5190	6920	11245	18210	24580	40530	53380
	Breaking Strength (N)	20760	27680	44980	69200	93420	141860	186840
	Elongation at MTL (mm/m)	4	4	4	4	4	4	4
Kevlar	Max Traction Load (N)	4215	5620	9135	14800	19980	32940	41775
	Breaking Strength (N)	16870	22495	36555	56240	75920	115290	146220
	Elongation at MTL (mm/m)	8	8	8	8	8	8	8
HP	Max Traction Load (N)	-	10400	16000	25260	34525	56685	74970
	Breaking Strength (N)	-	41600	64000	96000	131200	198400	262400
	Elongation at MTL (mm/m)	-	4	4	4	4	4	4
HF	Max Traction Load (N)	5775	7700	12510	20260	27355	45100	59400
	Breaking Strength (N)	23100	30800	50050	77000	103950	157850	207900
	Elongation at MTL (mm/m)	5	5	5	5	5	5	5

Average values

FLEXION RESISTANCE

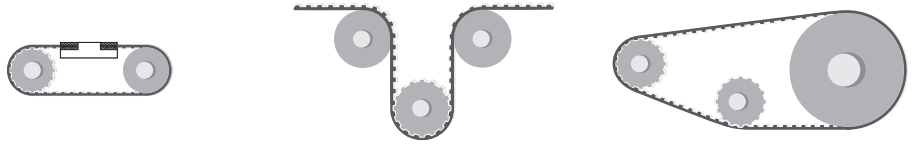

	Z_{min}	Z_{min}	Idler min dia (mm)	Z_{min}	Idler min dia (mm)
Standard steel cords	18	25	180	18	120
Kevlar cords	18	25	180	18	120
High Power cords	25	25	250	25	160
High Flexibility cords	18	25	150	18	120

JOINED BELT INFORMATIONS

- Minimum splice length 900 mm
- Traction and tooth resistances = 50% less than open-end
- Joined belt can be used only in conveyor systems
- Rolls with NFT, NFB, AVAFC and APL can be joined too
- Minimum diameters according above table
- For coated belts, minimum diameters on page 118



PULLEYS (for more details please see our pulleys catalogue)

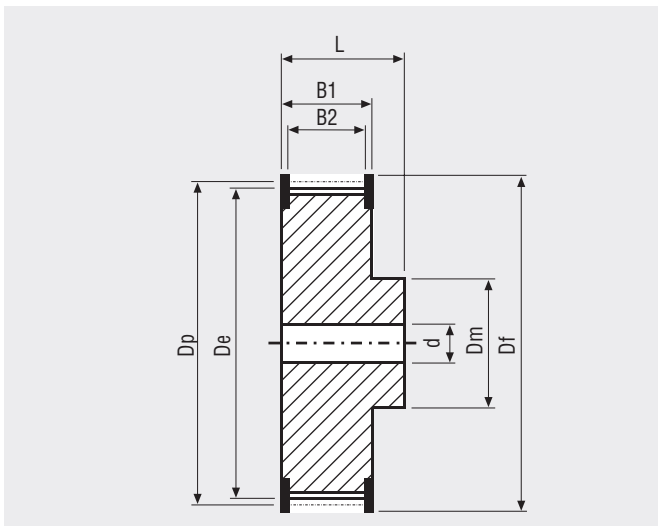

N° Teeth	Dp	De	N° Teeth	Dp	De
18	114,59	111,73	32	203,72	200,86
20	127,32	124,47	36	229,18	226,33
22	140,06	137,20	40	254,65	251,80
24	152,79	149,93	48	305,58	302,73
25	159,15	156,30	60	381,97	379,12
30	190,99	188,13			

MEGALINEAR MTD3 OPEN-END

BELT CHARACTERISTICS

STANDARD WIDTHS (mm)	10	20	25	50
Weight (gr/m)	20	45	60	115

Standard compound: **white Polyurethane thermoplastic 92 ShA**

Standard back cover: **none**

Standard tooth cover: **none**

Standard cords: **S and Z torsion zinked steel**

Standard width tolerance: **+/- 0,3 mm**

Standard thickness: **2,2 +/- 0,15 mm**

Standard length tolerance: **+/- 0,5 mm/m**

Standard roll length: **100 m**

Belt options on request with minimum quantity:

- Nylon fabric back
- Nylon fabric teeth
- Antistatic nylon fabric
- Transparent FDA compound



Different back coating materials see page 118

TOOTH PROFILE ACCORDING ISO 13050

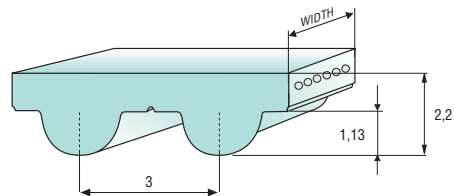

TOOTH RESISTANCE

RPM (1/min)	0	20	40	60	80	100	200	300	400	500	750	1000	1500	2000	3000	4000	5000	8000
F _{p spec} (N/cm)	23	23	22	22	22	22	21	20	20	19	18	17	16	15	13	12	11	9

Minimum suggested number of teeth in clamp for linear movement: 7

TRACTION RESISTANCE

Belt width (mm)		10	20	25	50
Steel	Max Traction Load (N)	410	820	1065	2170
	Breaking Strength (N)	1640	3280	4260	8690
	Elongation at MTL (mm/m)	4	4	4	4

Average values

FLEXION RESISTANCE

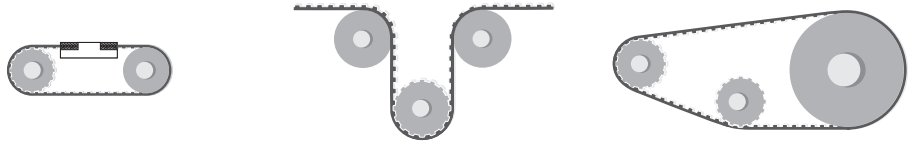

	Z_{min}	Z_{min}	Idler min dia (mm)	Z_{min}	Idler min dia (mm)
Standard steel cords	20	20	30	20	30

JOINED BELT INFORMATIONS

- Minimum splice length 900 mm
- Traction and tooth resistances = 50% less than open-end
- Joined belt can be used only in conveyor systems
- Rolls with NFT and NFB can be joined too
- Minimum diameters according above table
- For coated belts, minimum diameters on page 118

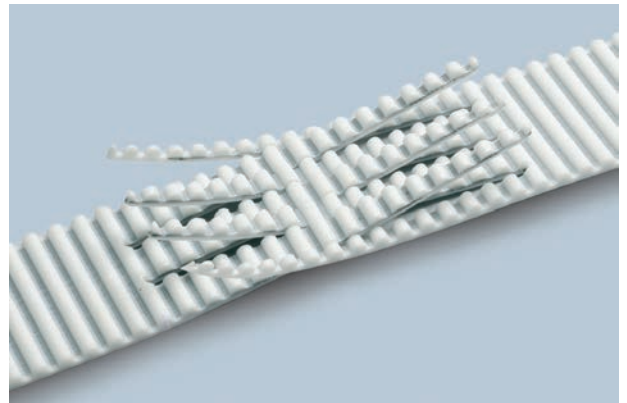

PULLEYS (for more details please see our pulleys catalogue)

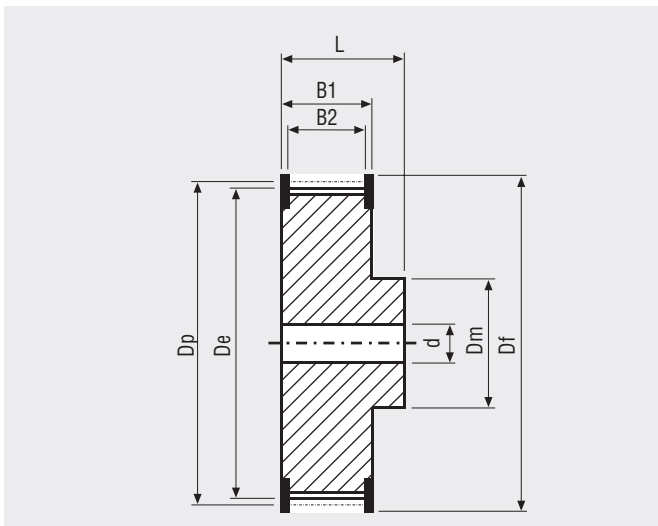

N° Teeth	Dp	De	N° Teeth	Dp	De
20	19,10	18,34	32	30,56	29,80
21	20,05	19,29	36	34,38	33,62
22	21,01	20,25	40	38,20	37,44
24	22,92	22,16	44	42,02	41,25
26	24,83	24,07	48	45,84	45,07
28	26,74	25,98	60	57,30	56,53
30	28,65	27,89	72	68,75	67,99

MEGALINEAR MTD5 OPEN-END

BELT CHARACTERISTICS

STANDARD WIDTHS (mm)	10	15	25	50
Weight (gr/m)	35	50	80	165

- Standard compound: **white Polyurethane thermoplastic 92 ShA**
- Standard back cover: **none**
- Standard tooth cover: **none**
- Standard cords: **S and Z torsion zinked steel**
- Standard width tolerance: **+/- 0,5 mm**
- Standard thickness: **3,6 +/- 0,2 mm**
- Standard length tolerance: **+/- 0,8 mm/m**
- Standard roll length: **100 m**
- Belt options on request with minimum quantity:
 - Nylon fabric back
 - Nylon fabric teeth
 - Antistatic nylon fabric
 - Cleats



Different back coating materials see page 118

TOOTH PROFILE ACCORDING ISO 13050

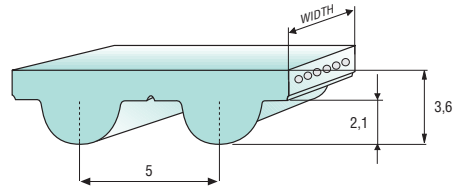

TOOTH RESISTANCE

RPM (1/min)	0	20	40	60	80	100	200	300	400	500	750	1000	1500	2000	3000	4000	5000	8000
F _{p spec} (N/cm)	34	34	33	33	33	32	31	30	29	28	26	25	23	21	19	17	16	13

Minimum suggested number of teeth in clamp for linear movement: 7

TRACTION RESISTANCE

Belt width (mm)		10	15	25	50
Steel	Max Traction Load (N)	670	1005	1805	3750
	Breaking Strength (N)	2680	4020	7235	15005
	Elongation at MTL (mm/m)	4	4	4	4
Kevlar	Max Traction Load (N)	665	995	1795	3720
	Breaking Strength (N)	2660	3990	7180	14895
	Elongation at MTL (mm/m)	8	8	8	8
Stainless	Max Traction Load (N)	520	780	1410	-
	Breaking Strength (N)	2090	3135	5640	-
	Elongation at MTL (mm/m)	3,8	3,8	3,8	-

Average values

FLEXION RESISTANCE

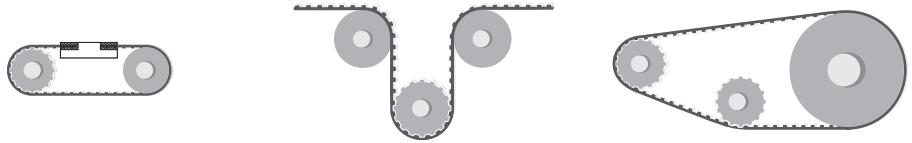

	Z_{min}	Z_{min}	Idler min dia (mm)	Z_{min}	Idler min dia (mm)
Standard steel cords	16	16	50	16	25
Kevlar cords	16	16	50	16	25
Stainless steel cords	18	20	65	18	65

JOINED BELT INFORMATIONS

- Minimum splice length 900 mm
- Traction and tooth resistances = 50% less than open-end
- Joined belt can be used only in conveyor systems
- Rolls with NFT, NFB, AVAFC and APL can be joined too
- Minimum diameters according above table
- For coated belts, minimum diameters on page 118

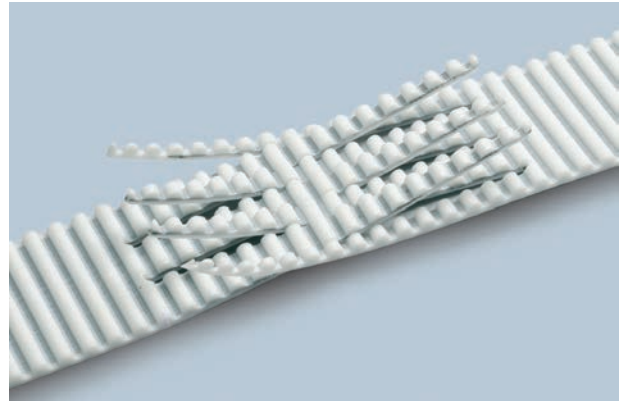

PULLEYS (for more details please see our pulleys catalogue)

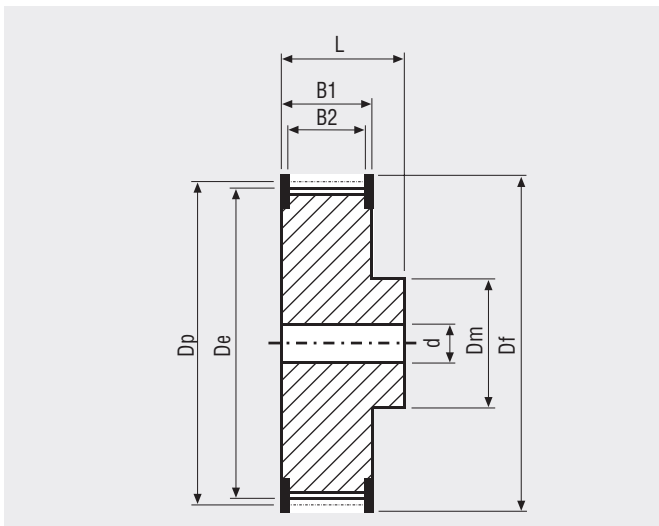

N° Teeth	Dp	De	N° Teeth	Dp	De
16	25,46	24,32	30	47,75	46,60
18	28,65	27,50	32	50,93	49,79
20	31,83	30,69	36	57,30	56,15
21	33,42	32,28	40	63,66	62,52
22	35,01	33,87	44	70,03	68,89
24	38,20	37,05	48	76,39	75,25
26	41,38	40,24	60	95,49	94,35
28	44,56	43,42	72	114,59	113,45

MEGALINEAR MTD8 OPEN-END

BELT CHARACTERISTICS

STANDARD WIDTHS (mm)	10	15	20	30	50	85	100
Weight (gr/m)	65	85	120	185	325	530	650

- Standard compound: **white Polyurethane thermoplastic 92 ShA**
- Standard back cover: **none**
- Standard tooth cover: **none**
- Standard cords: **S and Z torsion zinked steel**
- Standard width tolerance: **+/- 0,5 mm**
- Standard thickness: **5,6 +/- 0,3 mm**
- Standard length tolerance: **+/- 0,8 mm/m**
- Standard roll length: **100 m**
- Belt options on request with minimum quantity:
- Nylon fabric back
 - Nylon fabric teeth
 - Antistatic nylon fabric
 - Transparent FDA compound
 - AVAFC 60/70/85 ShA
 - APL
 - Fishbone
 - Ribbed
 - Cleats

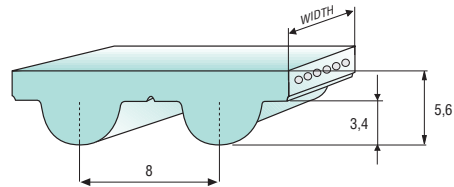

Different back coating materials see page 118

TOOTH PROFILE ACCORDING ISO 13050

TOOTH RESISTANCE

RPM (1/min)	0	20	40	60	80	100	200	300	400	500	750	1000	1500	2000	3000	4000	5000	8000
F _{p spec} (N/cm)	67	66	65	64	63	63	59	57	54	52	48	45	40	37	31	28	24	18

Minimum suggested number of teeth in clamp for linear movement: 7

TRACTION RESISTANCE

Belt width (mm)		10	15	20	30	50	85	100
HP = Standard	Max Traction Load (N)	1425	2135	3085	4750	8075	14750	17500
	Breaking Strength (N)	5700	8550	12350	19000	32300	56050	66500
	Elongation at MTL (mm/m)	4	4	4	4	4	4	4
Kevlar	Max Traction Load (N)	765	1150	1535	2565	4360	7965	9450
	Breaking Strength (N)	3075	4615	6155	10260	17440	30265	35910
	Elongation at MTL (mm/m)	8	8	8	8	8	8	8
HF	Max Traction Load (N)	840	1365	1890	2940	5040	9170	10830
	Breaking Strength (N)	3360	5460	7560	11760	20160	34860	41160
	Elongation at MTL (mm/m)	5	5	5	5	5	5	5
Stainless	Max Traction Load (N)	1075	1610	2330	3585	6095	-	-
	Breaking Strength (N)	4300	6455	9320	14345	24385	-	-
	Elongation at MTL (mm/m)	3,8	3,8	3,8	3,8	3,8	-	-

Average values

FLEXION RESISTANCE

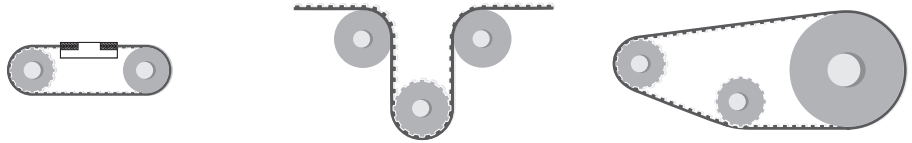

	Z_{min}	Z_{min}	Idler min dia (mm)	Z_{min}	Idler min dia (mm)
HP = Standard	20	22	100	20	50
Kevlar cords	20	22	100	20	50
High Flexibility cords	20	20	80	20	40
Stainless steel cords	24	28	110	24	80

JOINED BELT INFORMATIONS

- Minimum splice length 900 mm
- Traction and tooth resistances = 50% less than open-end
- Joined belt can be used only in conveyor systems
- Rolls with NFT, NFB, AVAFC and APL can be joined too
- Minimum diameters according above table
- For coated belts, minimum diameters on page 118

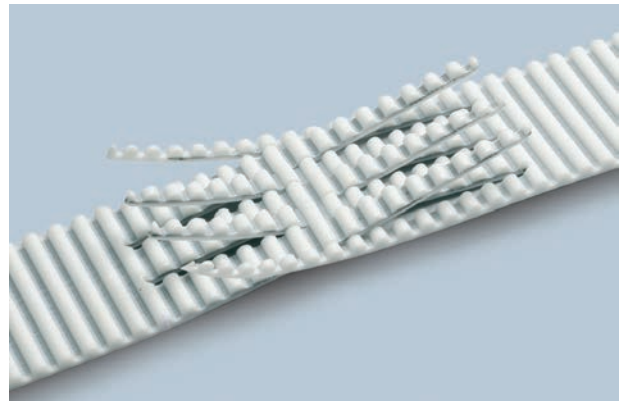

PULLEYS (for more details please see our pulleys catalogue)

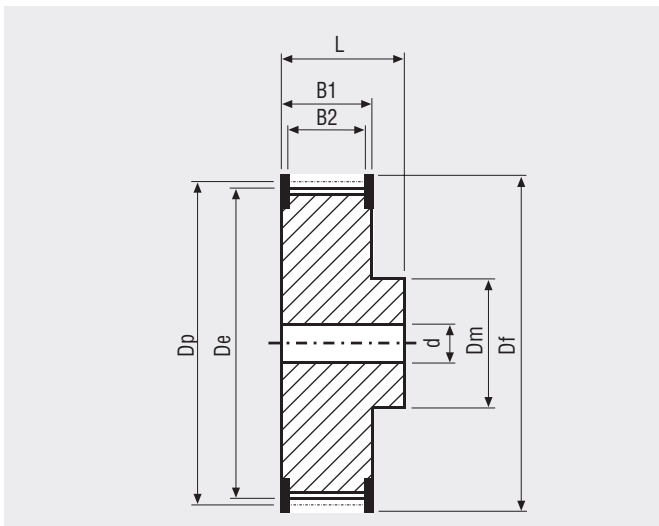

N° Teeth	Dp	De	N° Teeth	Dp	De
20	50,95	49,58	44	112,05	110,67
22	56,02	54,65	48	122,23	120,86
24	61,12	59,75	56	142,60	141,23
26	66,21	64,84	64	162,97	161,60
28	71,30	70,08	72	183,35	181,97
30	76,39	75,13	80	203,72	202,35
32	81,49	80,16	90	229,18	227,81
34	86,58	85,22	112	285,21	283,83
36	91,67	90,30	144	366,69	365,32
38	96,77	95,39	168	427,81	426,44
40	101,86	100,49	192	488,92	487,55

MEGALINEAR MTD14 OPEN-END

BELT CHARACTERISTICS

STANDARD WIDTHS (mm)	25	40	55	85	100	115
Weight (gr/m)	260	400	555	850	1000	1150

- Standard compound: **white Polyurethane thermoplastic 92 ShA**
- Standard back cover: **none**
- Standard tooth cover: **none**
- Standard cords: **S and Z torsion zinked steel**
- Standard width tolerance: **+/- 1 mm**
- Standard thickness: **10 +/- 0,45 mm**
- Standard length tolerance: **+/- 0,8 mm/m**
- Standard roll length: **100 m**
- Belt options on request with minimum quantity:
 - Nylon fabric back
 - Nylon fabric teeth
 - Antistatic nylon fabric
 - Transparent FDA compound
 - AVAFC 60/70/85 ShA
 - APL
 - Fishbone
 - Ribbed
 - Cleats

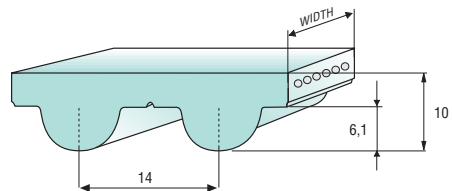

Different back coating materials see page 118

TOOTH PROFILE ACCORDING ISO 13050

TOOTH RESISTANCE

RPM (1/min)	0	20	40	60	80	100	200	300	400	500	750	1000	1500	2000	3000	4000	5000
F _{p spec} (N/cm)	115	113	111	109	108	106	99	93	88	84	76	69	60	52	46	34	28

Minimum suggested number of teeth in clamp for linear movement: 7

TRACTION RESISTANCE

Belt width (mm)		25	40	55	85	100	115
Steel	Max Traction Load (N)	5190	8650	12745	20485	24580	30150
	Breaking Strength (N)	20760	34600	48440	77850	93420	105530
	Elongation at MTL (mm/m)	4	4	4	4	4	4
Kevlar	Max Traction Load (N)	4215	7030	10360	16650	19980	24500
	Breaking Strength (N)	16870	28120	39365	63270	75920	85765
	Elongation at MTL (mm/m)	8	8	8	8	8	8

Average values

FLEXION RESISTANCE



	Z_{min}	Z_{min}	Idler min dia (mm)	Z_{min}	Idler min dia (mm)
Standard steel cords	26	28	180	26	120
Kevlar cords	26	28	180	26	120

JOINED BELT INFORMATIONS

- Minimum splice length 900 mm
- Traction and tooth resistances = 50% less than open-end
- Joined belt can be used only in conveyor systems
- Rolls with NFT, NFB, AVAFC and APL can be joined too
- Minimum diameters according above table
- For coated belts, minimum diameters on page 118

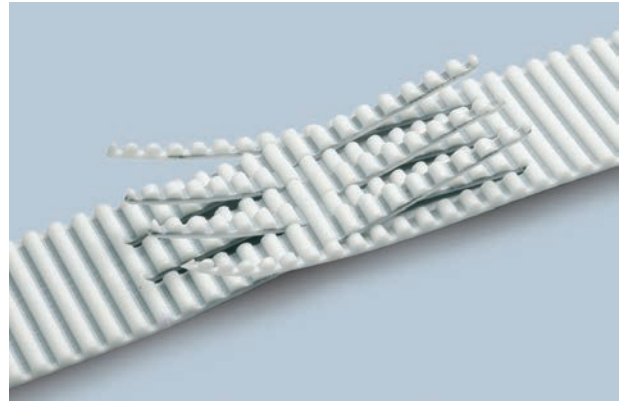

PULLEYS (for more details please see our pulleys catalogue)

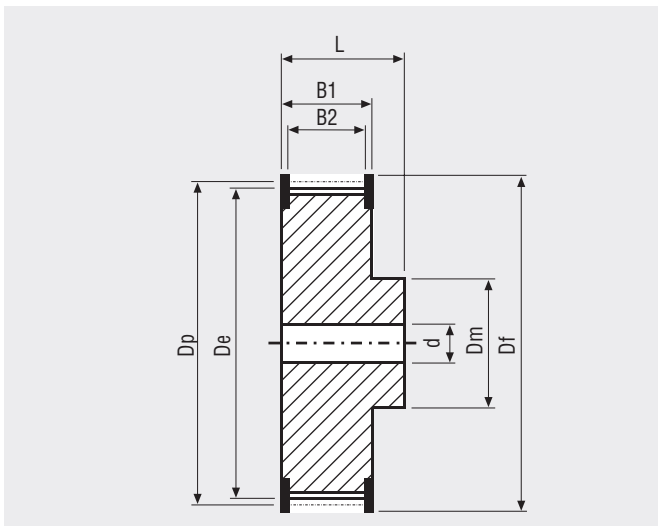

N° Teeth	Dp	De	N° Teeth	Dp	De
26	115,92	113,13	56	249,55	246,76
28	124,78	121,98	64	285,21	282,41
29	129,23	126,44	72	320,86	318,06
30	133,69	130,90	80	356,51	353,71
32	142,60	139,81	90	401,07	398,28
34	151,51	148,72	112	499,11	496,32
36	160,43	157,68	144	641,71	638,92
38	169,34	166,60	168	748,66	745,87
40	178,25	175,49	192	855,62	852,82
44	196,08	193,28	216	962,57	959,76
48	213,90	211,11			

MEGALINEAR RPP5 OPEN-END

BELT CHARACTERISTICS

STANDARD WIDTHS (mm)	10	15	25	30	50	75
Weight (gr/m)	40	60	100	120	195	292

Standard compound: **white Polyurethane thermoplastic 92 ShA**

Standard back cover: **none**

Standard tooth cover: **nylon fabric (NFT)**

Standard cords: **S and Z torsion zinked steel**

Standard width tolerance: **+/- 0,5 mm**

Standard thickness: **3,8 +/- 0,2 mm**

Standard length tolerance: **+/- 0,8 mm/m**

HP cord length tolerance: **+0/- 0,8 mm/m**

Standard roll length: **100 m**

Belt options on request with minimum quantity:

- Nylon fabric back
- Antistatic nylon fabric
- AVAFc 60/70/85 ShA
- APL
- Cleats

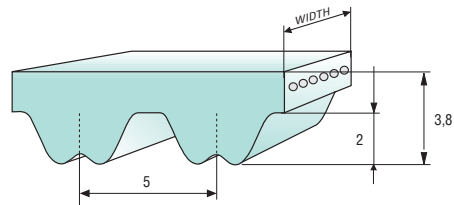
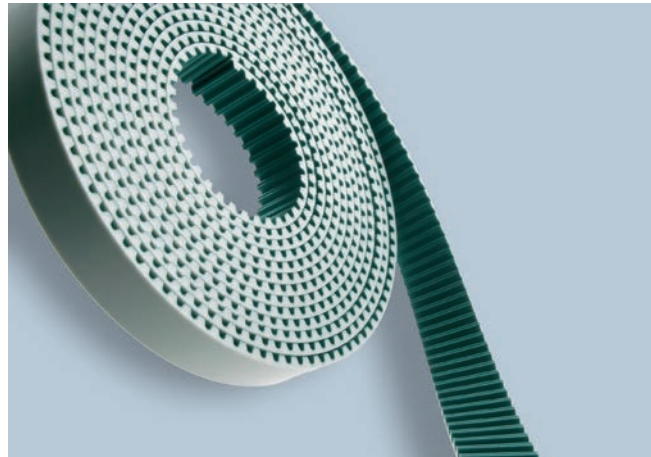

Different back coating materials see page 118

TOOTH PROFILE ACCORDING ISO 13050

TOOTH RESISTANCE

RPM (1/min)	0	20	40	60	80	100	200	300	400	500	750	1000	1500	2000	3000	4000	5000	8000
F _{p spec} (N/cm)	37	36	36	36	35	35	33	32	30	30	27	26	24	23	21	19	18	15

Minimum suggested number of teeth in clamp for linear movement: 7 - HP cords minimum suggested number of teeth in clamp 10

TRACTION RESISTANCE

Belt width (mm)		10	15	25	30	50	75
Steel	Max Traction Load (N)	670	1005	1805	2210	3750	6065
	Breaking Strength (N)	2680	4020	7235	8840	15005	23045
	Elongation at MTL (mm/m)	4	4	4	4	4	4
Kevlar	Max Traction Load (N)	665	995	1795	2190	3720	-
	Breaking Strength (N)	2660	3990	7180	8775	14895	-
	Elongation at MTL (mm/m)	8	8	8	8	8	-
Stainless	Max Traction Load (N)	520	780	1410	-	-	-
	Breaking Strength (N)	2090	3135	5640	-	-	-
	Elongation at MTL (mm/m)	3,8	3,8	3,8	-	-	-
HP	Max Traction Load (N)	840	1365	2415	2940	5040	8065
	Breaking Strength (N)	3360	5460	9660	11760	20160	30660
	Elongation at MTL (mm/m)	4	4	4	4	4	4

Average values

FLEXION RESISTANCE

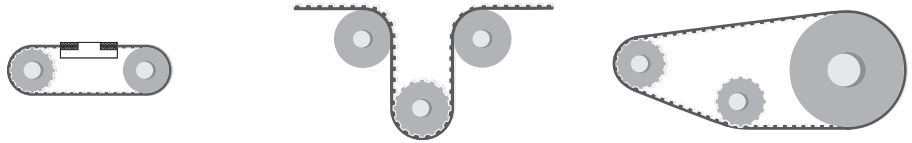

	Z_{min}	Z_{min}	Idler min dia (mm)	Z_{min}	Idler min dia (mm)
Standard steel cords	15	16	60	15	20
Kevlar cords	15	16	60	15	20
Stainless steel cords	18	18	65	18	65
High power cords	20	22	60	20	40

JOINED BELT INFORMATIONS

- Minimum splice length 900 mm
- Traction and tooth resistances = 50% less than open-end
- Joined belt can be used only in conveyor systems
- Rolls with NFT, NFB, AVAFC and APL can be joined too
- Minimum diameters according above table
- For coated belts, minimum diameters on page 118

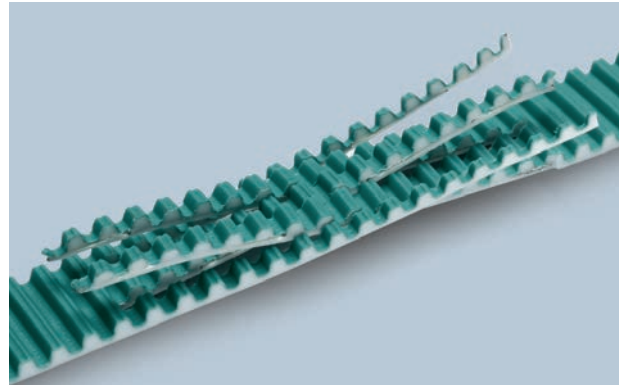

PULLEYS (for more details please see our pulleys catalogue)

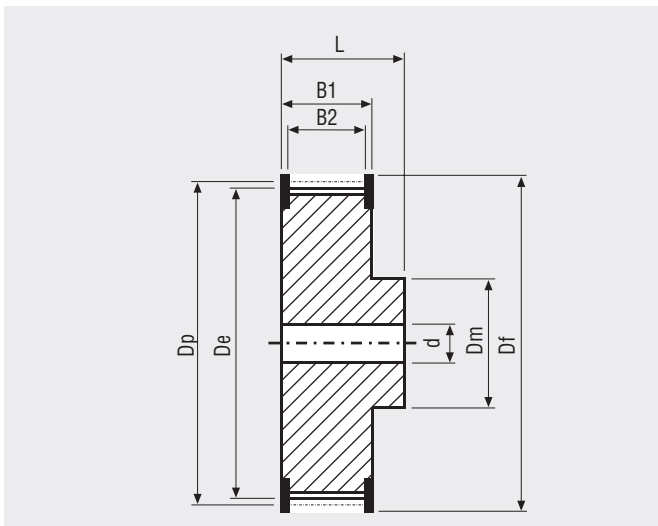

N° Teeth	Dp	De	N° Teeth	Dp	De
15	23,87	22,73	30	47,75	46,60
16	25,46	24,32	32	50,93	49,79
18	28,65	27,50	36	57,30	56,15
20	31,83	30,69	40	63,66	62,52
21	33,42	32,28	44	70,03	68,89
22	35,01	33,87	48	76,39	75,25
24	38,20	37,05	60	95,49	94,35
26	41,38	40,24	72	114,59	113,45
28	44,56	43,42			

MEGALINEAR RPP8 OPEN-END

BELT CHARACTERISTICS

STANDARD WIDTHS (mm)	10	15	20	30	50	85	100
Weight (gr/m)	65	100	130	195	330	560	655

Standard compound: **white Polyurethane thermoplastic 92 ShA**

Standard back cover: **none**

Standard tooth cover: **nylon fabric (NFT)**

Standard cords: **S and Z torsion zinked steel**

Standard width tolerance: **+/- 0,5 mm**

Standard thickness: **5,4 +/- 0,3 mm**

Standard length tolerance: **+/- 0,8 mm/m**

HP cord length tolerance: **+0/- 0,8 mm/m**

Standard roll length: **100 m**

Belt options on request with minimum quantity:

- Nylon fabric back
- Antistatic nylon fabric
- AVAFC 60/70/85 ShA
- APL
- Fishbone
- Ribbed
- Cleats

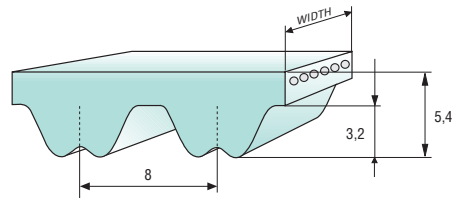
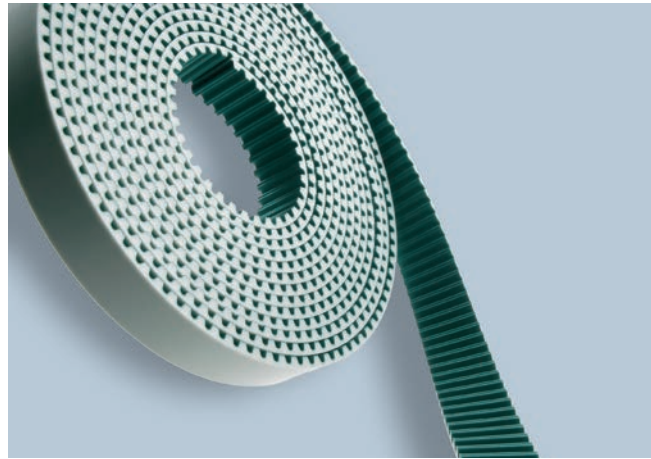

Different back coating materials see page 118

TOOTH PROFILE ACCORDING ISO 13050

TOOTH RESISTANCE

RPM (1/min)	0	20	40	60	80	100	200	300	400	500	750	1000	1500	2000	3000	4000	5000	8000
F _{p spec} (N/cm)	76	75	74	73	72	71	65	62	60	57	53	50	45	42	38	35	32	25

Minimum suggested number of teeth in clamp for linear movement: 7- HP cords minimum suggested number of teeth in clamp 10

TRACTION RESISTANCE

Belt width (mm)		10	15	20	30	50	85	100
Steel	Max Traction Load (N)	1425	2135	3085	4750	8075	14750	17500
	Breaking Strength (N)	5700	8550	12350	19000	32300	56050	66500
	Elongation at MTL (mm/m)	4	4	4	4	4	4	4
Kevlar	Max Traction Load (N)	1110	1665	2405	3705	6295	11505	13650
	Breaking Strength (N)	4445	6665	9630	14820	25190	43715	51870
	Elongation at MTL (mm/m)	8	8	8	8	8	8	8
HP	Max Traction Load (N)	2160	3460	4755	7785	12975	24125	27770
	Breaking Strength (N)	8650	13840	19030	31140	51900	91690	105530
	Elongation at MTL (mm/m)	4	4	4	4	4	4	4

Average values

FLEXION RESISTANCE

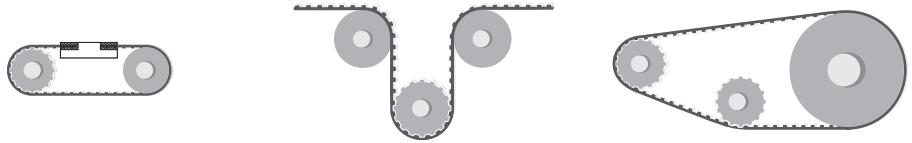

	Z_{min}	Z_{min}	Idler min dia (mm)	Z_{min}	Idler min dia (mm)
Standard steel cords	18	20	100	18	45
Kevlar cords	18	20	100	18	45
High power cords	30	34	180	30	60

JOINED BELT INFORMATIONS

- Minimum splice length 900 mm
- Traction and tooth resistances = 50% less than open-end
- Joined belt can be used only in conveyor systems
- Rolls with NFT, NFB, AVAFC and APL can be joined too
- Minimum diameters according above table
- For coated belts, minimum diameters on page 118

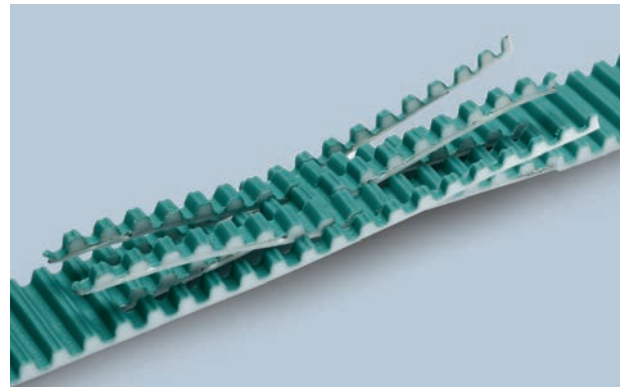

PULLEYS (HP belts can't work on RPP or MTD standard pulleys, a special profile is required. Please contact Megadyne staff for more information)

SPECIAL SHAPE IS REQUIRED

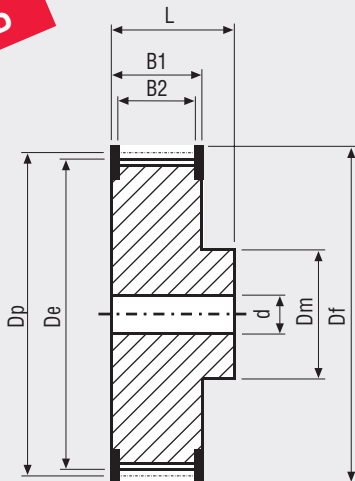

N° Teeth	Dp	De	N° Teeth	Dp	De
18	45,86	44,49	44	112,04	110,67
22	56,02	54,65	48	122,23	120,86
24	61,12	59,74	54	137,51	136,14
26	66,21	64,84	64	162,97	161,60
28	71,30	69,93	72	183,35	181,97
30	76,39	75,02	80	203,72	202,35
32	81,49	80,12	90	229,18	227,81
34	86,58	85,21	112	285,20	283,83
36	91,67	90,30	144	366,69	365,32
38	96,77	95,39	168	427,81	426,44
40	101,86	100,49	192	488,92	487,55

MEGALINEAR RPP14 OPEN-END

BELT CHARACTERISTICS

STANDARD WIDTHS (mm)	40	55	85	115	150
Weight (gr/m)	505	610	1080	1465	1958

- Standard compound: **white Polyurethane thermoplastic 92 ShA**
- Standard back cover: **none**
- Standard tooth cover: **nylon fabric (NFT)**
- Standard cords: **S and Z torsion zinked steel**
- Standard width tolerance: **+/- 1 mm**
- Standard thickness: **10 +/- 0,4 mm**
- Standard length tolerance: **+/- 0,8 mm/m**
- Standard roll length: **100 m**
- Belt options on request with minimum quantity:
 - Nylon fabric back
 - Antistatic nylon fabric
 - AVAFC 60/70/85 ShA
 - APL
 - Fishbone
 - Ribbed
 - Cleats

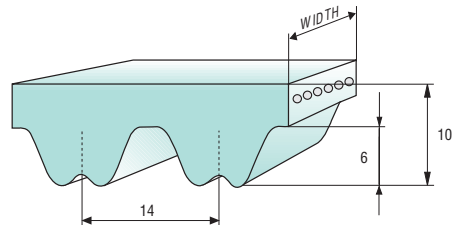
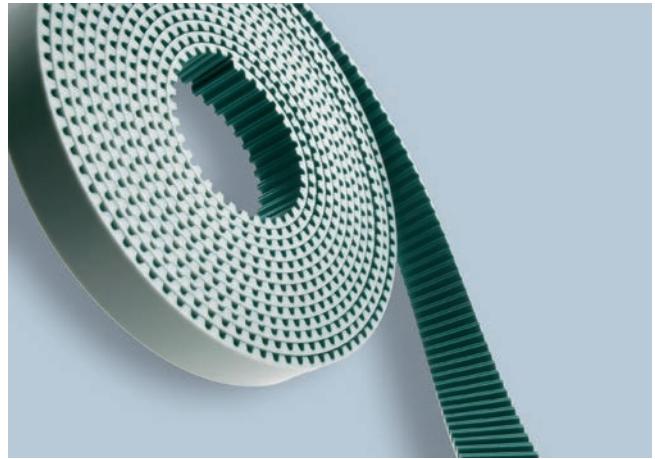

Different back coating materials see page 118

TOOTH PROFILE ACCORDING ISO 13050

TOOTH RESISTANCE

RPM (1/min)	0	20	40	60	80	100	200	300	400	500	750	1000	1500	2000	3000	4000	5000
F _{p spec} (N/cm)	140	137	135	133	131	128	118	111	105	101	91	84	75	62	52	40	30

Minimum suggested number of teeth in clamp for linear movement: 8

TRACTION RESISTANCE

Belt width (mm)		40	55	85	115	150
Steel	Max Traction Load (N)	15200	22000	35000	51025	67310
	Breaking Strength (N)	60800	83600	133000	178600	235600
	Elongation at MTL (mm/m)	4	4	4	4	4

Average values

FLEXION RESISTANCE

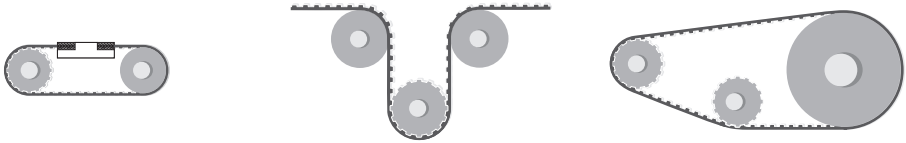

	Z_{min}	Z_{min}	Idler min dia (mm)	Z_{min}	Idler min dia (mm)
Standard steel cords	32	34	250	32	145

JOINED BELT INFORMATIONS

- Minimum splice length 900 mm
- Traction and tooth resistances = 50% less than open-end
- Joined belt can be used only in conveyor systems
- Rolls with NFT, NFB, AVAFC and APL can be joined too
- Minimum diameters according above table
- For coated belts, minimum diameters on page 118

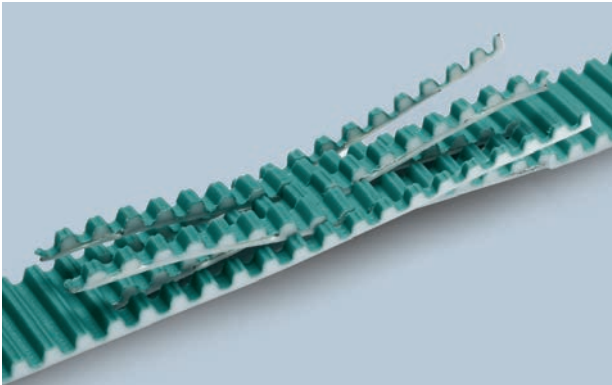

PULLEYS (for more details please see our pulleys catalogue)

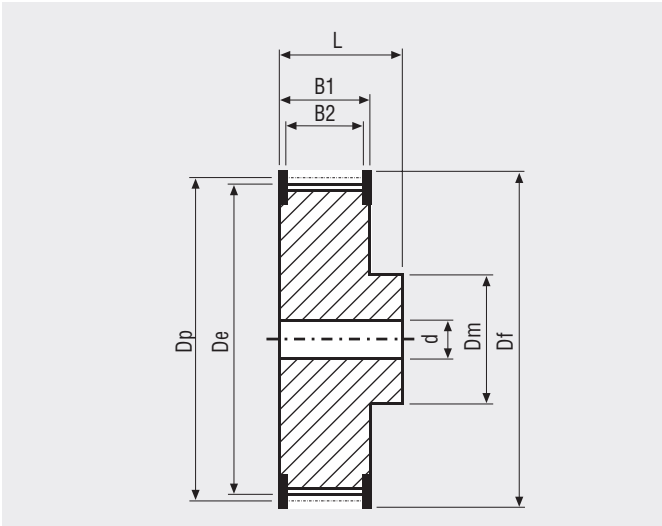

N° Teeth	Dp	De	N° Teeth	Dp	De
32	142,60	139,81	72	320,86	318,07
34	151,52	148,73	80	356,51	353,72
36	160,43	157,64	90	401,07	398,28
38	169,34	166,55	112	499,11	496,32
40	178,25	175,46	144	641,71	638,92
44	196,08	193,29	168	748,66	745,87
48	213,90	211,11	192	855,61	852,82
56	249,55	246,76	216	962,57	959,78
64	285,20	282,41			

MEGALINEAR RPP14XHP OPEN-END

BELT CHARACTERISTICS

STANDARD WIDTHS (mm)	40	55	85	115	150
Weight (gr/m)	640	900	1380	1890	2485

Standard compound: **white Polyurethane thermoplastic 92 ShA**
 Standard back cover: **none**
 Standard tooth cover: **nylon fabric (NFT)**
 Standard cords: **S and Z torsion zinked steel**
 Standard width tolerance: **+/- 1 mm**
 Standard thickness: **10,2 +/- 0,5 mm**
 Standard length tolerance: **-0,4/-1,2 mm/m**
 Standard roll length: **100 m**

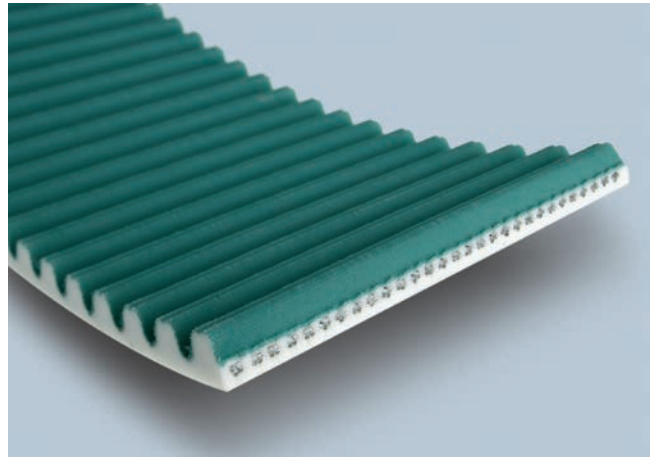

TOOTH PROFILE ACCORDING ISO 13050

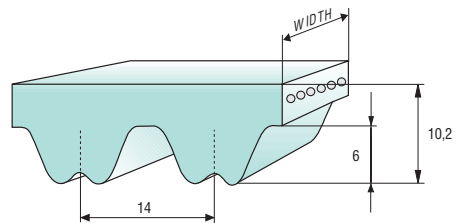

TOOTH RESISTANCE

RPM (1/min)	0	20	40	60	80	100	200	300	400	500	750	1000	1500	2000	3000	4000	5000
$F_{p\ spec}$ (N/cm)	140	137	135	133	131	128	118	111	105	101	91	84	75	62	52	40	30

Minimum suggested number of teeth in clamp for linear movement: 12

TRACTION RESISTANCE

Belt width (mm)		40	55	85	115	150
Steel	Max Traction Load (N)	19800	30316	47365	69940	92570
	Breaking Strength (N)	79200	115200	180000	244800	324000
	Elongation at MTL (mm/m)	4	4	4	4	4

Average values

FLEXION RESISTANCE

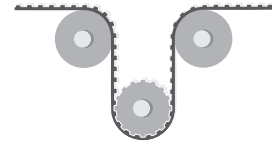
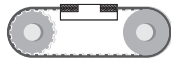

	Z_{min}	Z_{min}	Idler min dia (mm)
Standard steel cords	32	34	250

TYPICAL BELT APPLICATION



PULLEYS (XHP belts can't work on RPP or HTD standard pulleys, a special profile is required. PLS contact Megadyne staff for more information)

SPECIAL SHAPE IS REQUIRED

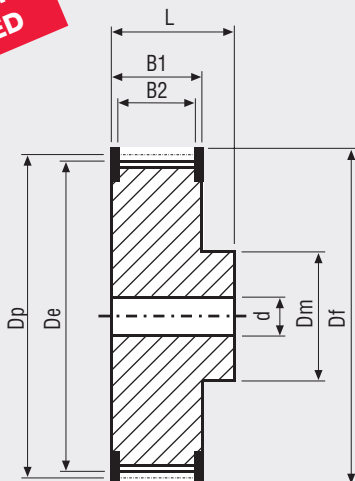

N° Teeth	Dp	De	N° Teeth	Dp	De
32	142,60	139,81	72	320,86	318,07
34	151,52	148,73	80	356,51	353,72
36	160,43	157,64	90	401,07	398,28
38	169,34	166,55	112	499,11	496,32
40	178,25	175,46	144	641,71	638,92
44	196,08	193,29	168	748,66	745,87
48	213,90	211,11	192	855,61	852,82
56	249,55	246,76	216	962,57	959,78
64	285,20	282,41			

MEGALINEAR STD5 OPEN-END

BELT CHARACTERISTICS

STANDARD WIDTHS (mm)	10	15	25	50
Weight (gr/m)	35	50	80	165

Standard compound: **black Polyurethane thermoplastic 92 ShA**
 Standard back cover: **none**
 Standard tooth cover: **antistatic nylon fabric (NFT)**
 Standard cords: **S and Z torsion zinked steel**
 Standard width tolerance: **+/- 0,5 mm**
 Standard thickness: **3,4 +/- 0,25 mm**
 Standard length tolerance: **+/- 0,8 mm/m**
 Standard roll length: **100 m**
 Belt options on request with minimum quantity:
 Nylon fabric back
 AVAFC 60/70/85 ShA
 APL
 Cleats

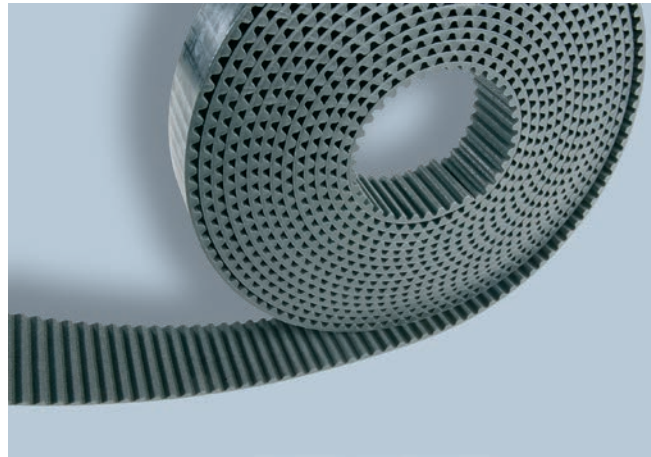

Different back coating materials see page 118

TOOTH PROFILE ACCORDING ISO 13050

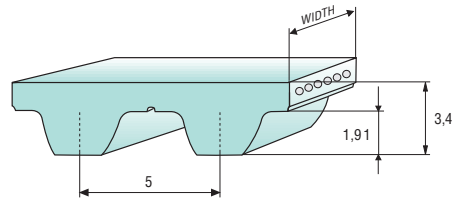

TOOTH RESISTANCE

RPM (1/min)	0	20	40	60	80	100	200	300	400	500	750	1000	1500	2000	3000	4000	5000	8000
F _{p spec} (N/cm)	34	34	33	32	31	30	29	27	25	24	22	20	17	15	12	10	8	3

Minimum suggested number of teeth in clamp for linear movement: 7

TRACTION RESISTANCE

Belt width (mm)		10	15	25	50
Steel	Max Traction Load (N)	670	1005	1805	3750
	Breaking Strength (N)	2680	4020	7235	15005
	Elongation at MTL (mm/m)	4	4	4	4

Average values

FLEXION RESISTANCE

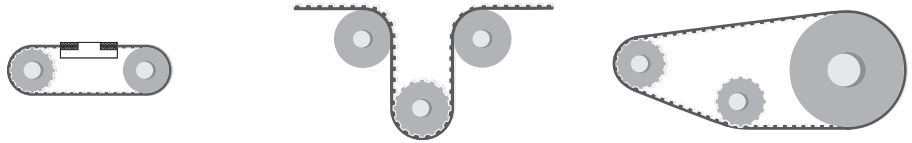

	Z_{min}	Z_{min}	Idler min dia (mm)	Z_{min}	Idler min dia (mm)
Standard steel cords	12	13	60	12	20

JOINED BELT INFORMATIONS

- Minimum splice length 900 mm
- Traction and tooth resistances = 50% less than open-end
- Joined belt can be used only in conveyor systems
- Rolls with NFT, NFB, AVAFC and APL can be joined too
- Minimum diameters according above table
- For coated belts, minimum diameters on page 118

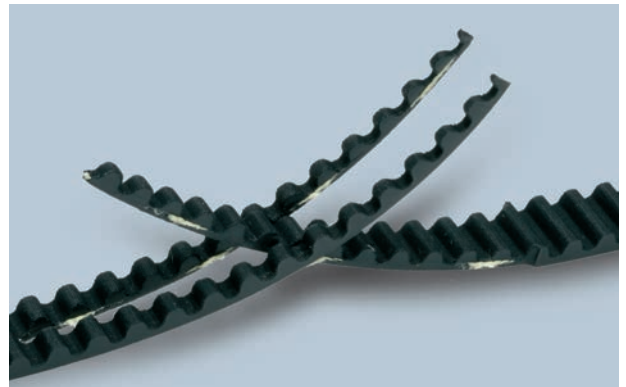

PULLEYS (for more details please see our pulleys catalogue)

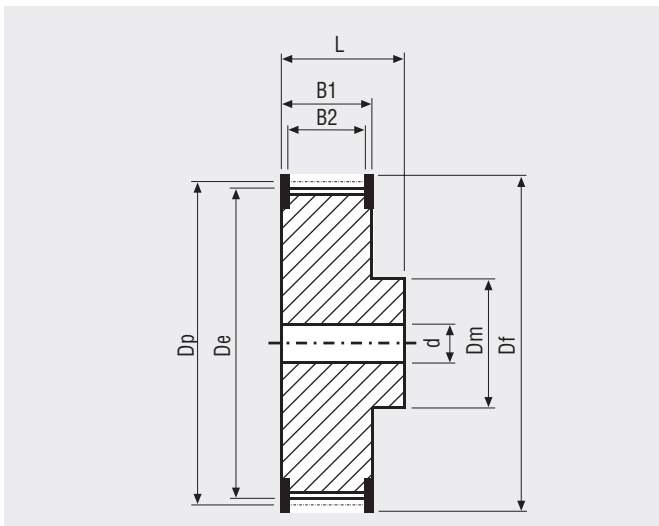

N° Teeth	Dp	De	N° Teeth	Dp	De
12	19,10	18,14	28	44,58	43,60
14	22,29	21,32	30	47,77	46,79
15	23,88	22,91	32	50,95	49,79
16	25,47	24,50	36	57,32	56,34
18	28,66	27,69	40	63,69	62,70
20	31,84	30,87	44	70,06	69,07
22	35,03	34,05	48	76,43	75,43
24	38,21	37,24	60	95,54	94,53
26	41,40	40,42	72	114,64	113,63

MEGALINEAR STD8 OPEN-END

BELT CHARACTERISTICS

STANDARD WIDTHS (mm)	10	12	15	20	30	50	85
Weight (gr/m)	65	75	85	120	185	325	530

Standard compound: **black Polyurethane thermoplastic 92 ShA**

Standard back cover: **none**

Standard tooth cover: **antistatic nylon fabric (NFT)**

Standard cords: **S and Z torsion zinked steel**

Standard width tolerance: **+/- 0,5 mm**

Standard thickness: **5,1 +/- 0,25 mm**

Standard length tolerance: **+/- 0,8 mm/m**

Standard roll length: **100 m**

Belt options on request with minimum quantity:

- Nylon fabric back
- AVAFC 60/70/85 ShA
- APL
- Fishbone
- Ribbed
- Cleats

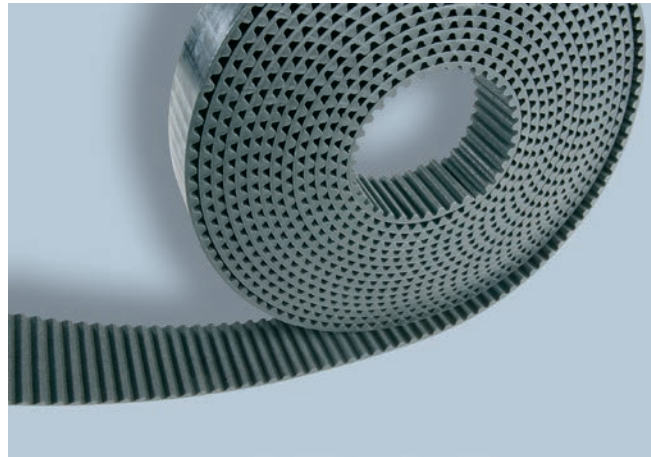

Different back coating materials see page 118

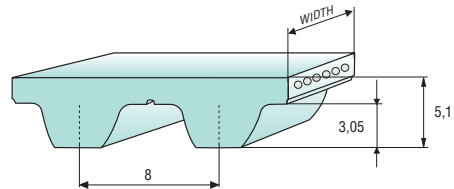

TOOTH PROFILE ACCORDING ISO 13050

TOOTH RESISTANCE

RPM (1/min)	0	20	40	60	80	100	200	300	400	500	750	1000	1500	2000	3000	4000	5000
F _{p spec} (N/cm)	64	62	58	56	54	51	48	46	44	42	38	35	31	27	23	20	17

Minimum suggested number of teeth in clamp for linear movement: 7

TRACTION RESISTANCE

Belt width (mm)		10	12	15	20	30	50	85
HP = Standard	Max Traction Load (N)	1425	1660	2135	3085	4750	8075	14750
	Breaking Strength (N)	5700	6650	8550	12350	19000	32300	56050
	Elongation at MTL (mm/m)	4	4	4	4	4	4	4
Kevlar	Max Traction Load (N)	1110	1295	1665	2405	3705	6295	11505
	Breaking Strength (N)	4445	5185	6665	9630	14820	25190	43715
	Elongation at MTL (mm/m)	8	8	8	8	8	8	8
HF	Max Traction Load (N)	840	1050	1365	1890	2940	5040	9170
	Breaking Strength (N)	3360	4200	5460	7560	11760	20160	34860
	Elongation at MTL (mm/m)	5	5	5	5	5	5	5

Average values

FLEXION RESISTANCE

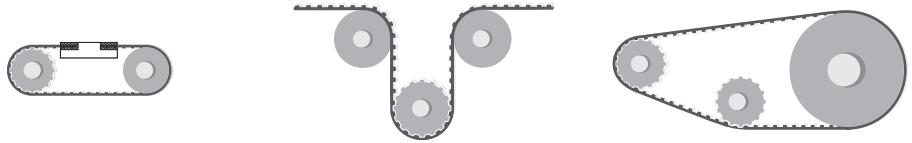

	Z_{min}	Z_{min}	Idler min dia (mm)	Z_{min}	Idler min dia (mm)
HP = standard	20	24	100	20	50
Kevlar cords	20	24	100	20	50
High Flexibility cords	16	24	60	22	40

JOINED BELT INFORMATIONS

- Minimum splice length 900 mm
- Traction and tooth resistances = 50% less than open-end
- Joined belt can be used only in conveyor systems
- Rolls with NFT, NFB, AVAFC and APL can be joined too
- Minimum diameters according above table
- For coated belts, minimum diameters on page 118

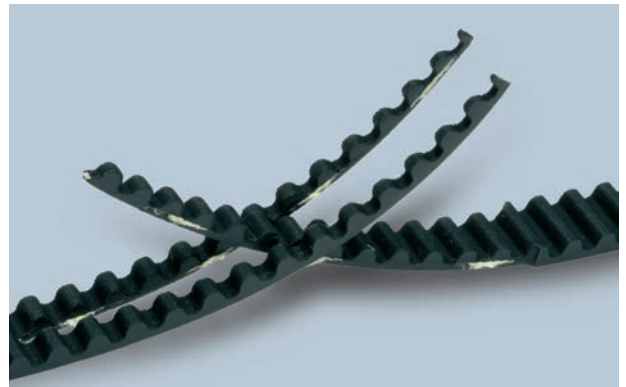

PULLEYS (for more details please see our pulleys catalogue)

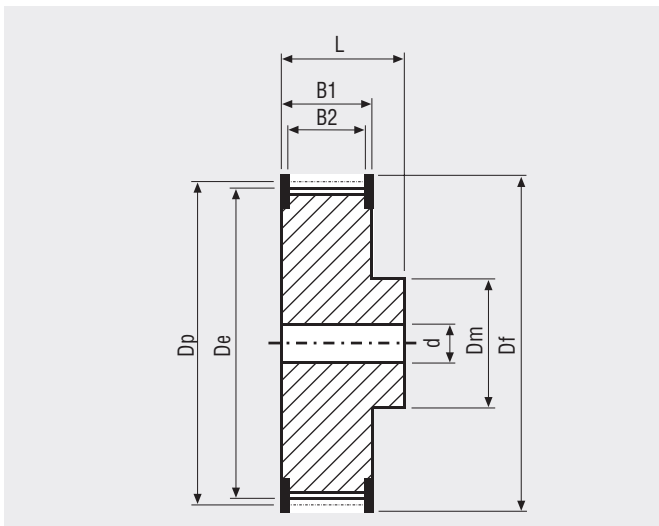

N° Teeth	Dp	De	N° Teeth	Dp	De
22	56,05	54,65	48	122,29	120,86
24	61,14	59,75	56	142,67	141,23
26	66,24	64,84	64	163,05	161,60
28	71,33	69,93	72	183,43	181,98
30	76,43	75,02	80	203,82	202,35
32	81,52	80,12	90	229,29	227,81
34	86,62	85,21	112	285,35	283,84
36	91,71	90,30	144	366,87	365,32
38	96,81	95,40	168	428,02	426,44
40	101,91	100,49	192	489,17	487,55
44	112,10	110,68			

MEGALINEAR HG OPEN-END

BELT CHARACTERISTICS

STANDARD WIDTHS (inch)	150	200	300	400	600
STANDARD WIDTHS (mm)	38,1	50,8	76,2	101,6	152,4
Weight (gr/m)	230	285	395	500	800

Standard compound: **white Polyurethane thermoplastic 92 ShA**

Standard back cover: **none**

Standard tooth cover: **none**

Standard cords: **S and Z torsion zinked steel**

Standard width tolerance: **+/- 0,5 mm**

Standard length tolerance: **+/- 0,8 mm/m**

Standard roll length: **100 m**

Belt options on request with minimum quantity:

- Nylon fabric back
- Nylon fabric teeth*
- Antistatic nylon fabric
- Transparent FDA compound
- Cleats

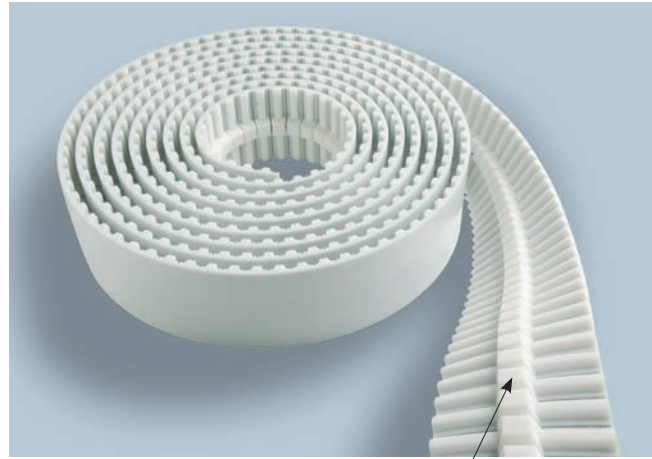

Different back coating materials see page 118

* Nylon fabric teeth including guide (fabric on complete width) is standard version.
 Nylon fabric teeth excluding guide (2 fabric strips on teeth only) is only on request.

notched guide

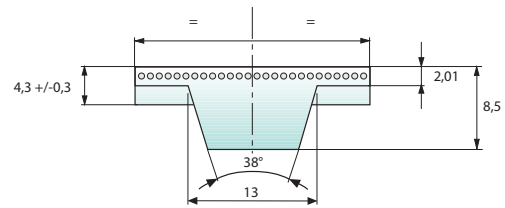

TOOTH RESISTANCE

RPM (1/min)	0	20	40	60	80	100	200	300	400	500	750	1000	1500	2000	3000	4000	5000	8000
F _{p spec} (N/cm)	44	43	42	41	40	39	36	34	33	31	29	27	24	22	19	17	16	12

Minimum suggested number of teeth in clamp for linear movement: 7

TRACTION RESISTANCE

Belt width (inch)		150	200	300	400	600
Steel	Max Traction Load (N)	3675	5040	8065	11760	11520
	Breaking Strength (N)	14700	20160	30660	41160	40320
	Elongation at MTL (mm/m)	4	4	4	4	4
Kevlar	Max Traction Load (N)	3205	4360	7015	10260	14360
	Breaking Strength (N)	12825	17440	26675	35910	50270
	Elongation at MTL (mm/m)	8	8	8	8	8

Average values

FLEXION RESISTANCE

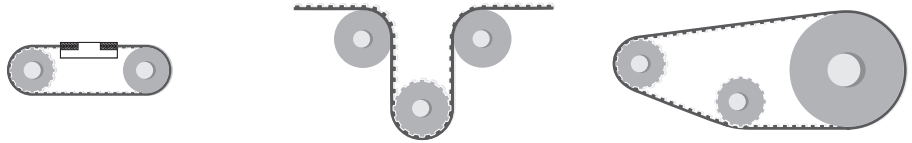

	Z_{min}	Z_{min}	Idler min dia (mm)	Z_{min}	Idler min dia (mm)
Standard steel cords	20	22	160	20	80
Kevlar cords	20	22	160	20	80

JOINED BELT INFORMATIONS

- Minimum splice length 900 mm
- Traction and tooth resistances = 50% less than open-end
- Joined belt can be used only in conveyor systems
- Rolls with NFT and NFB can be joined too
- Minimum diameters according above table
- For coated belts, minimum diameters on page 118

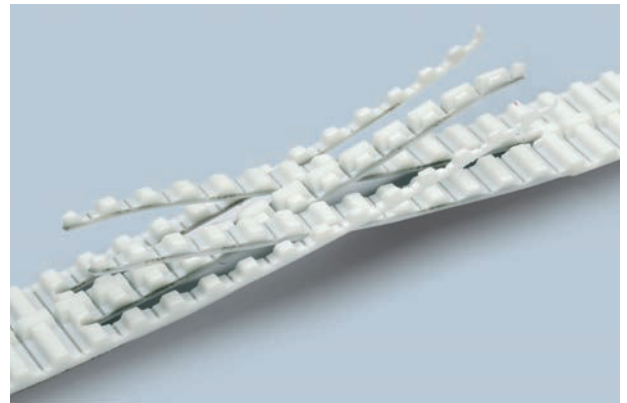

PULLEYS (for more details please see our pulleys catalogue)

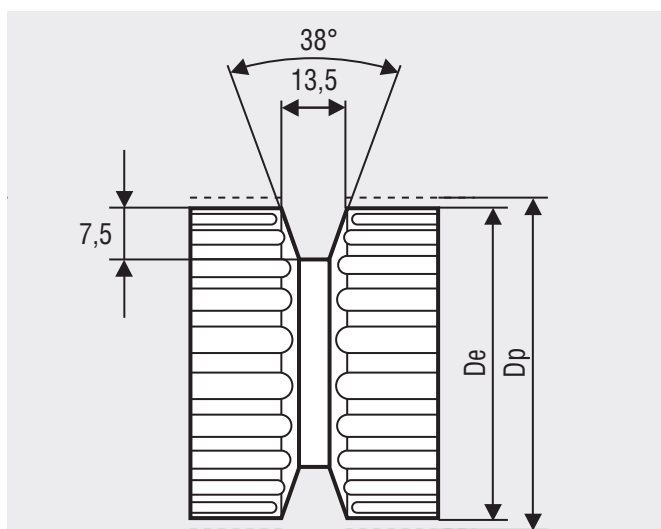

N° Teeth	Dp	De	N° Teeth	Dp	De
20	80,85	79,48	34	137,45	136,08
22	88,94	87,57	36	145,53	144,16
24	97,02	95,65	38	153,62	152,25
26	105,11	103,74	40	161,70	160,33
28	113,19	111,82	44	177,87	176,50
30	121,28	119,91	48	194,04	192,67
32	129,36	127,99	60	242,55	241,18

MEGALINEAR TG5 OPEN-END

BELT CHARACTERISTICS

STANDARD WIDTHS (mm)	25	32	50
Weight (gr/m)	70	85	120

- Standard compound: **white Polyurethane thermoplastic 92 ShA**
- Standard back cover: **none**
- Standard tooth cover: **none**
- Standard cords: **S and Z torsion zinked steel**
- Standard width tolerance: **+/- 0,5 mm**
- Standard length tolerance: **+/- 0,8 mm/m**
- Standard roll length: **100 m**
- Belt options on request with minimum quantity:
 - Nylon fabric back
 - Nylon fabric teeth*
 - Antistatic nylon fabric
 - Transparent FDA compound
 - Cleats

Different back coating materials see page 118

* Nylon fabric teeth excluding guide (2 fabric strips on teeth only).

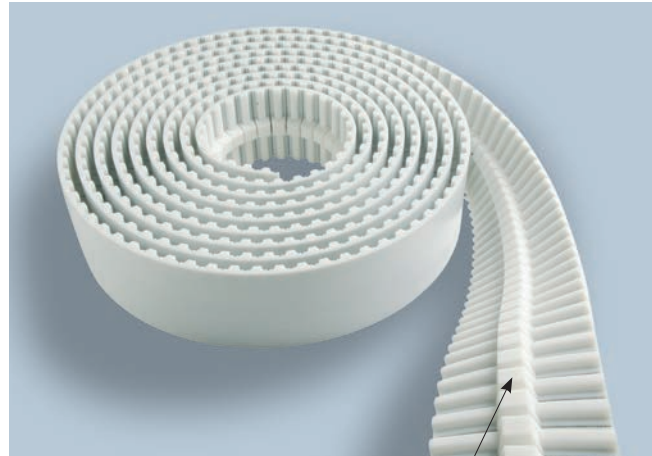

notched guide

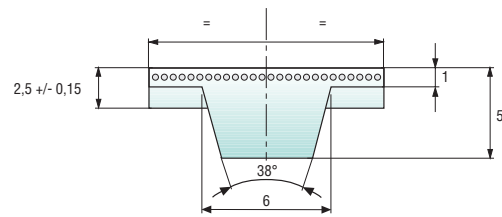

TOOTH RESISTANCE

RPM (1/min)	0	20	40	60	80	100	200	300	400	500	750	1000	1500	2000	3000	4000	5000	8000
F _{p spec} (N/cm)	24	23	23	22	22	22	20	19	19	18	17	16	15	14	12	11	11	9

Minimum suggested number of teeth in clamp for linear movement: 7

TRACTION RESISTANCE

Belt width (mm)		25	32	50
Steel	Max Traction Load (N)	840	1060	1750
	Breaking Strength (N)	3375	4250	7000
	Elongation at MTL (mm/m)	4	4	4
Kevlar	Max Traction Load (N)	1795	2260	3720
	Breaking Strength (N)	7180	9040	14895
	Elongation at MTL (mm/m)	8	8	8

Average values

FLEXION RESISTANCE

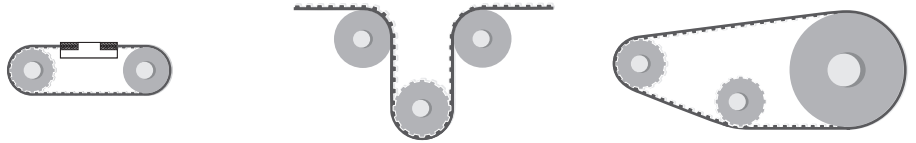

	Z_{min}	Z_{min}	Idler min dia (mm)	Z_{min}	Idler min dia (mm)
Standard steel cords	25	28	80	25	60
Kevlar cords	25	28	80	25	60

JOINED BELT INFORMATIONS

- Minimum splice length 900 mm
- Traction and tooth resistances = 50% less than open-end
- Joined belt can be used only in conveyor systems
- Rolls with NFT and NFB can be joined too
- Minimum diameters according above table
- For coated belts, minimum diameters on page 118

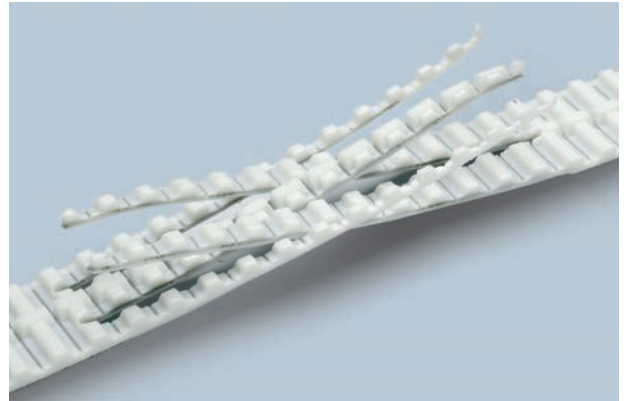

PULLEYS (for more details please see our pulleys catalogue)

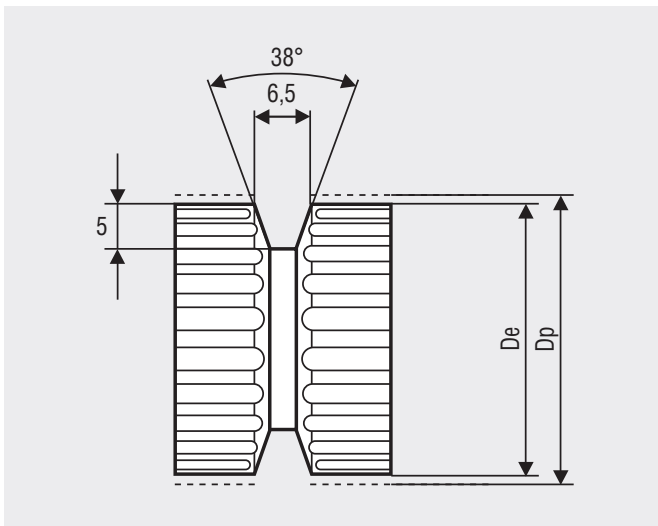

N° Teeth	Dp	De	N° Teeth	Dp	De
25	39,79	38,96	36	57,30	56,47
27	42,97	42,14	40	63,66	62,93
30	47,75	46,92	48	76,39	75,57
32	50,93	50,10	60	95,49	94,67

MEGALINEAR TG10 OPEN-END

BELT CHARACTERISTICS

STANDARD WIDTHS (mm)	25TG10K13	32TG10K13	50TG10K13	75TG10K13	100TG10K13	50TG10K6
Weight (gr/m)	190	250	290	390	495	240

Standard compound: **white Polyurethane thermoplastic 92 ShA**

Standard back cover: **none**

Standard tooth cover: **none**

Standard cords: **S and Z torsion zinked steel**

Standard width tolerance: **+/- 0,5 mm**

Standard length tolerance: **+/- 0,8 mm/m**

Standard roll length: **100 m**

Belt options on request with minimum quantity:

- Nylon fabric back
- Nylon fabric teeth*
- Antistatic nylon fabric
- Transparent FDA compound
- AVAFc 60/70/85 ShA
- Cleats

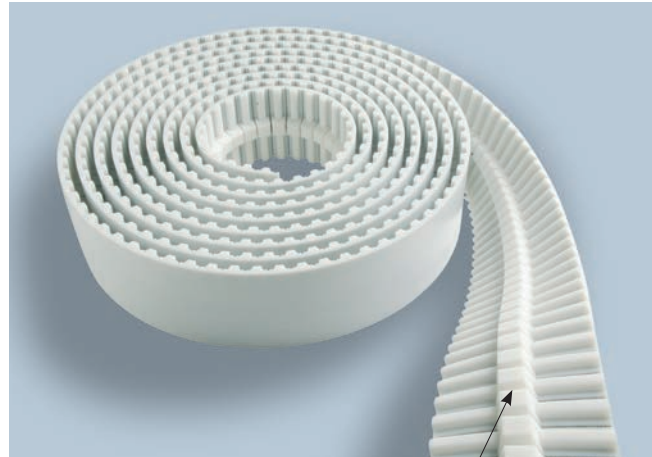

notched guide

Different back coating materials see page 118

*K13 - Nylon fabric teeth excluding guide (2 fabric strips on teeth only) is standard version.

Nylon fabric teeth including guide (fabric on complete width) is only on request.

K6 - Nylon fabric teeth including guide (fabric on complete width) is standard version.

Nylon fabric teeth excluding guide (2 fabric strips on teeth only) is only on request.

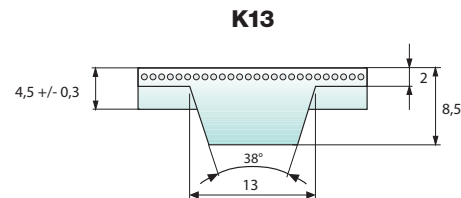
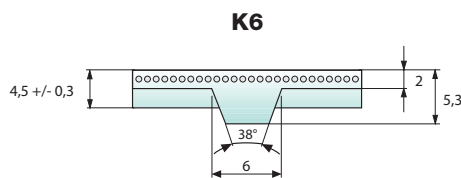

TOOTH RESISTANCE

RPM (1/min)	0	20	40	60	80	100	200	300	400	500	750	1000	1500	2000	3000	4000	5000	8000
F _{p spec} (N/cm)	51	49	48	47	46	45	41	39	37	36	33	31	28	25	22	20	18	14

Minimum suggested number of teeth in clamp for linear movement: 7

TRACTION RESISTANCE

Belt width (mm)		25TG10K13	32TG10K13	50TG10K13	75TG10K13	100TG10K13	50TG10K6
Steel	Max Traction Load (N)	2415	3045	5040	8065	10830	5040
	Breaking Strength (N)	9660	12180	20160	30660	41160	20160
	Elongation at MTL (mm/m)	4	4	4	4	4	4
Kevlar	Max Traction Load (N)	2050	2565	4360	7020	9450	4360
	Breaking Strength (N)	8205	10260	17440	26675	35910	17440
	Elongation at MTL (mm/m)	8	8	8	8	8	8
Stainless	Max Traction Load (N)	1855	2340	3875	-	-	3875
	Breaking Strength (N)	7425	9365	15500	-	-	15500
	Elongation at MTL (mm/m)	3,8	3,8	3,8	-	-	3,8

Average values

FLEXION RESISTANCE

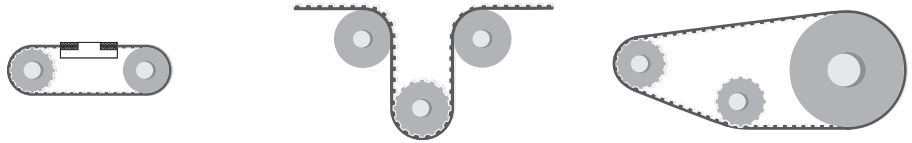

	Z_{min}	Z_{min}	Idler min dia (mm)	Z_{min}	Idler min dia (mm)
Standard steel cords	25	28	80	25	80
Kevlar cords	25	28	80	25	80
Stainless steel cords	31	34	90	31	90

JOINED BELT INFORMATIONS

- Minimum splice length 900 mm
- Traction and tooth resistances = 50% less than open-end
- Joined belt can be used only in conveyor systems
- Rolls with NFT, NFB, and AVAFC can be joined too
- Minimum diameters according above table
- For coated belts, minimum diameters on page 118

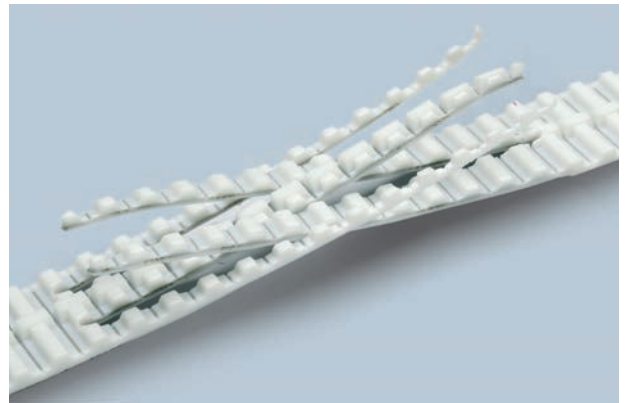

PULLEYS (for more details please see our pulleys catalogue)

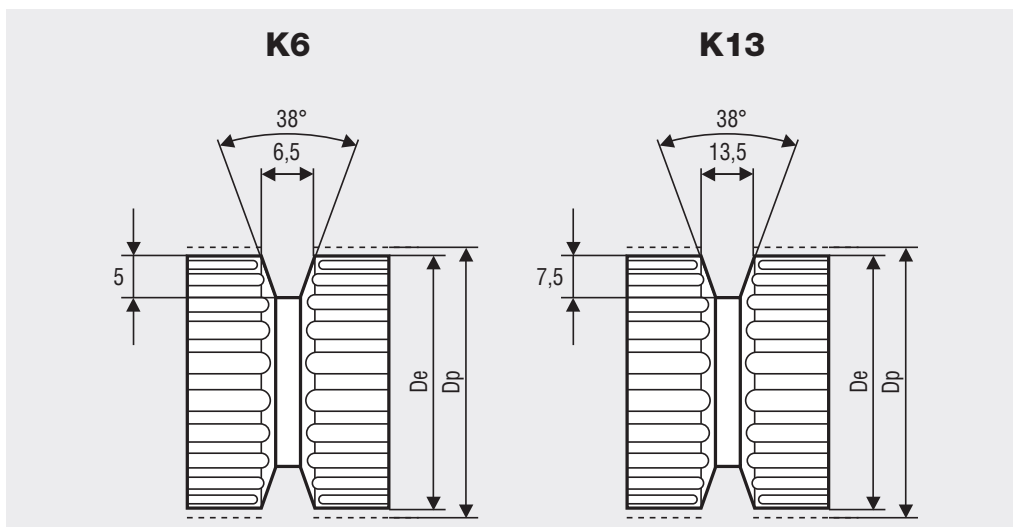

N° Teeth	Dp	De
25	79,58	77,73
27	85,94	84,10
30	95,49	93,65
32	101,86	100,01
36	114,59	112,74
40	127,32	125,48
48	152,79	150,94
60	190,99	189,14

MEGALINEAR TG20 OPEN-END

BELT CHARACTERISTICS

STANDARD WIDTHS (mm)	50	75	100
Weight (gr/m)	375	590	770

Standard compound: **white Polyurethane thermoplastic 92 ShA**

Standard back cover: **none**

Standard tooth cover: **none**

Standard cords: **S and Z torsion zinked steel**

Standard width tolerance: **+/- 1 mm**

Standard length tolerance: **+/- 0,8 mm/m**

Standard roll length: **100 m**

Belt options on request with minimum quantity:

- Nylon fabric back
- Nylon fabric teeth*
- Antistatic nylon fabric
- Transparent FDA compound
- Cleats

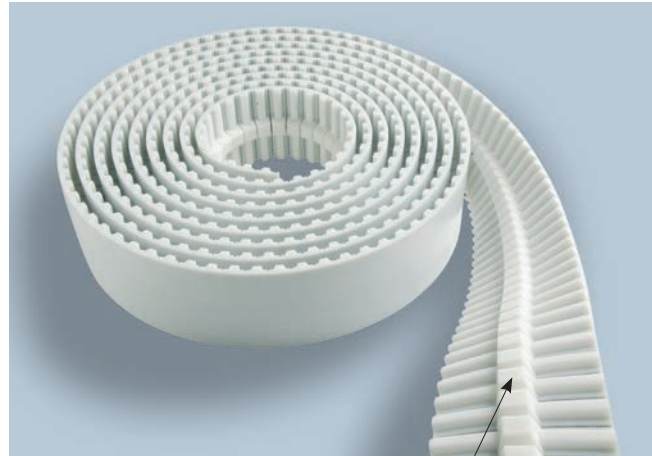

Different back coating materials see page 118

* Nylon fabric teeth including guide (fabric on complete width) is standard version.
 Nylon fabric teeth excluding guide (2 fabric strips on teeth only) is only on request.

notched guide

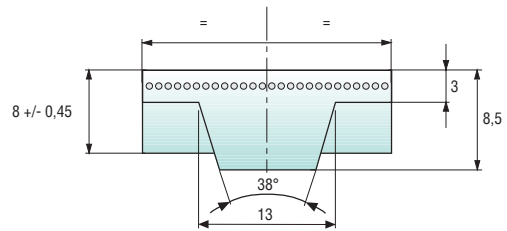

TOOTH RESISTANCE

RPM (1/min)	0	20	40	60	80	100	200	300	400	500	750	1000	1500	2000	3000	4000	5000
$F_{p\ spec}$ (N/cm)	102	98	95	93	91	89	81	76	72	68	62	57	50	45	38	33	29

Minimum suggested number of teeth in clamp for linear movement: 7

TRACTION RESISTANCE

Belt width (mm)		50	75	100
Steel	Max Traction Load (N)	8075	13000	17500
	Breaking Strength (N)	32300	49400	66500
	Elongation at MTL (mm/m)	4	4	4
Kevlar	Max Traction Load (N)	9135	14800	19975
	Breaking Strength (N)	36555	56240	75920
	Elongation at MTL (mm/m)	8	8	8

Average values

FLEXION RESISTANCE

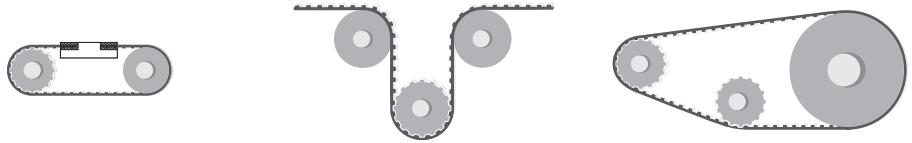

	Z_{min}	Z_{min}	Idler min dia (mm)	Z_{min}	Idler min dia (mm)
Standard steel cords	30	33	140	30	120
Kevlar cords	30	33	140	30	120

JOINED BELT INFORMATIONS

- Minimum splice length 900 mm
- Traction and tooth resistances = 50% less than open-end
- Joined belt can be used only in conveyor systems
- Rolls with NFT and NFB can be joined too
- Minimum diameters according above table
- For coated belts, minimum diameters on page 118

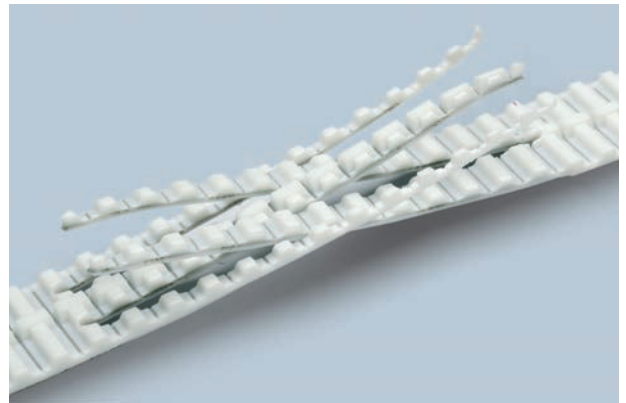

PULLEYS (for more details please see our pulleys catalogue)

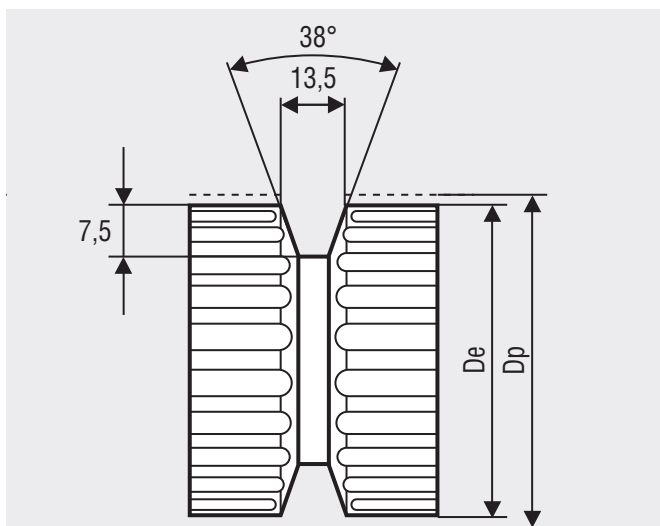

N° Teeth	Dp	De	N° Teeth	Dp	De
30	190,99	188,13	40	254,65	251,80
32	203,72	200,86	48	305,58	302,73
36	229,18	226,33	60	381,97	379,12

MEGALINEAR ATG5 OPEN-END

BELT CHARACTERISTICS

STANDARD WIDTHS (mm)	25	32	50
Weight (gr/m)	95	120	180

- Standard compound: **white Polyurethane thermoplastic 92 ShA**
- Standard back cover: **none**
- Standard tooth cover: **none**
- Standard cords: **S and Z torsion zinked steel**
- Standard width tolerance: **+/- 1 mm**
- Standard length tolerance: **+/- 0,8 mm/m**
- Standard roll length: **100 m**
- Belt options on request with minimum quantity:
 - Nylon fabric back
 - Nylon fabric teeth*
 - Antistatic nylon fabric
 - Transparent FDA compound
 - AVAFC 60/70/85 ShA
 - Cleats

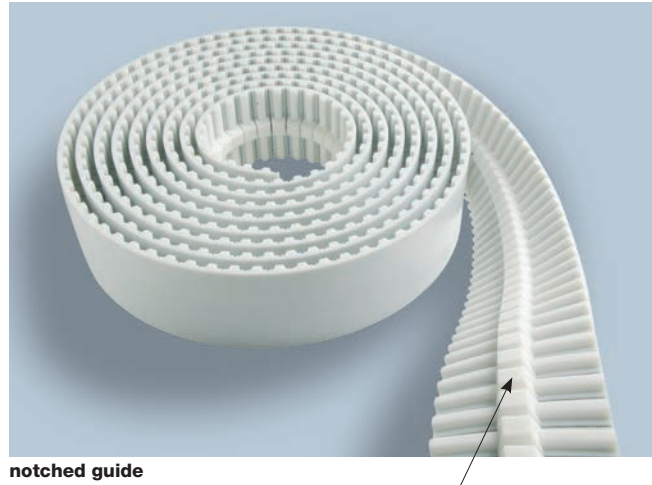

Different back coating materials see page 118

* Nylon fabric teeth excluding guide (2 fabric strips on teeth only).

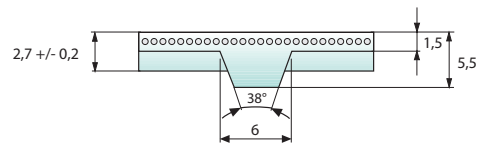

TOOTH RESISTANCE

RPM (1/min)	0	20	40	60	80	100	200	300	400	500	750	1000	1500	2000	3000	4000	5000	8000
F _{p spec} (N/cm)	35	35	35	34	34	34	32	31	30	29	27	26	24	22	19	18	16	13

Minimum suggested number of teeth in clamp for linear movement: 7

TRACTION RESISTANCE

Belt width (mm)		25	32	50
Steel	Max Traction Load (N)	1805	2275	3750
	Breaking Strength (N)	7235	9110	15005
	Elongation at MTL (mm/m)	4	4	4

Average values

FLEXION RESISTANCE

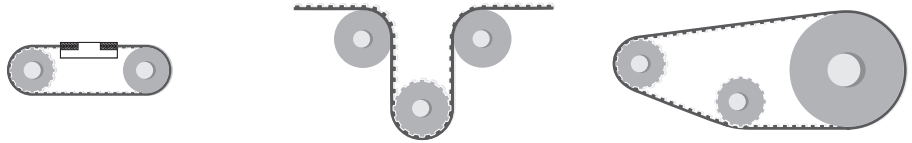

	Z_{min}	Z_{min}	Idler min dia (mm)	Z_{min}	Idler min dia (mm)
Standard steel cords	25	28	100	25	80

JOINED BELT INFORMATIONS

- Minimum splice length 900 mm
- Traction and tooth resistances = 50% less than open-end
- Joined belt can be used only in conveyor systems
- Rolls with NFT, NFB, and AVAFC can be joined too
- Minimum diameters according above table
- For coated belts, minimum diameters on page 118

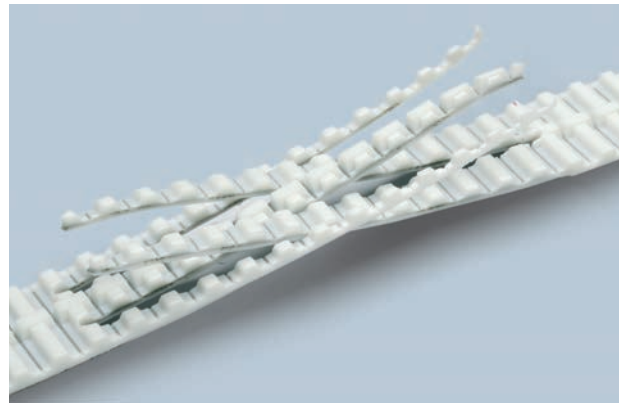

PULLEYS (for more details please see our pulleys catalogue)

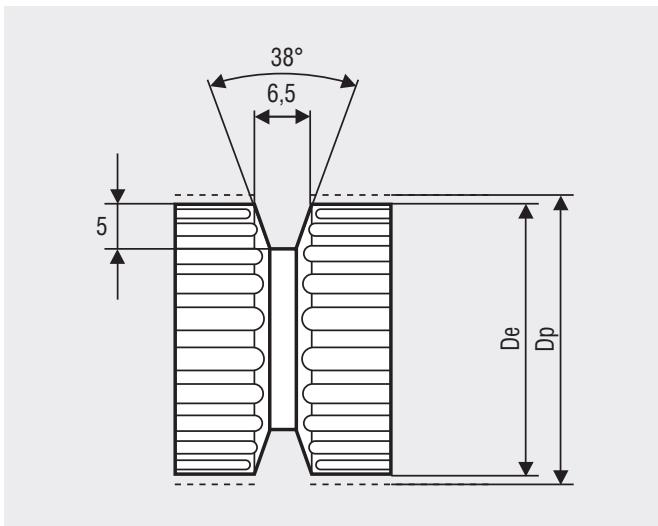

N° Teeth	Dp	De	N° Teeth	Dp	De
25	39,79	38,96	36	57,30	56,47
27	42,97	42,14	40	63,66	62,93
30	47,75	46,92	48	76,39	75,57
32	50,93	50,10	60	95,49	94,67

MEGALINEAR ATG10 OPEN-END

BELT CHARACTERISTICS

STANDARD WIDTHS (mm)	25 ATG10K13	32 ATG10K13	50 ATG10K13	75 ATG10K13	100 ATG10K13	150 ATG10K13	50 ATG10K6
Weight (gr/m)	180	230	330	465	620	930	290

Standard compound: **white Polyurethane thermoplastic 92 ShA**

Standard back cover: **none**

Standard tooth cover: **none**

Standard cords: **S and Z torsion zinked steel**

Standard width tolerance: **+/- 0,5 mm**

Standard length tolerance: **+/- 0,8 mm/m**

Standard roll length: **100 m**

Belt options on request with minimum quantity:

- Nylon fabric back
- Nylon fabric teeth*
- Antistatic nylon fabric
- Transparent FDA compound
- AVAFC 60/70/85 ShA
- Cleats

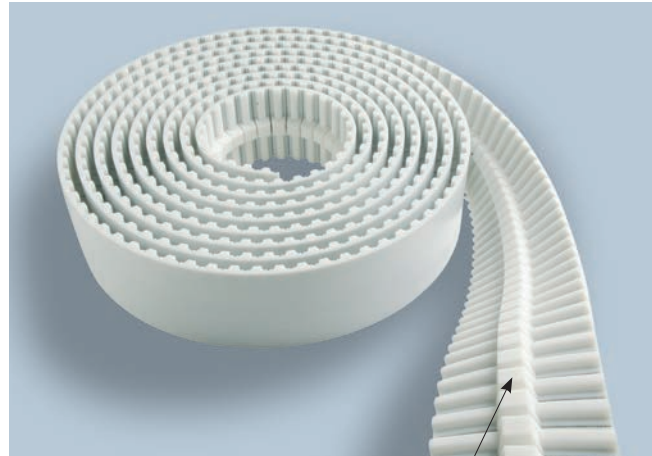

Different back coating materials see page 118

*K13 - Nylon fabric teeth excluding guide (2 fabric strips on teeth only) is standard version.

Nylon fabric teeth including guide (fabric on complete width) is only on request.

K6 - Nylon fabric teeth including guide (fabric on complete width) is standard version.

Nylon fabric teeth excluding guide (2 fabric strips on teeth only) is only on request.

notched guide

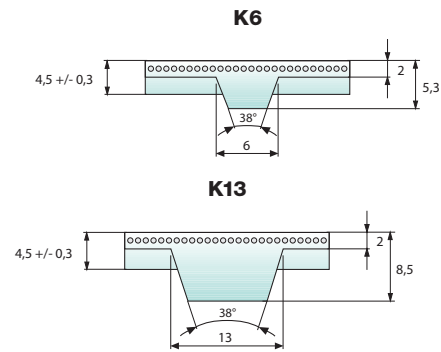

TOOTH RESISTANCE

RPM (1/min)	0	20	40	60	80	100	200	300	400	500	750	1000	1500	2000	3000	4000	5000	8000
F _{p spec} (N/cm)	74	72	71	71	70	69	65	62	60	58	53	50	44	40	35	30	27	20

Minimum suggested number of teeth in clamp for linear movement: 7

TRACTION RESISTANCE

Belt width (mm)		25 ATG10K13	32 ATG10K13	50 ATG10K13	75 ATG10K13	100 ATG10K13	150 ATG10K13	50 ATG10K6
Steel	Max Traction Load (N)	3800	4750	8075	13000	17500	28225	8075
	Breaking Strength (N)	15200	19000	32300	49400	66500	98800	32300
	Elongation at MTL (mm/m)	4	4	4	4	4	4	4
Kevlar	Max Traction Load (N)	4215	5620	9135	14800	19980	32940	9135
	Breaking Strength (N)	16870	22495	36555	56240	75920	115290	36555
	Elongation at MTL (mm/m)	8	8	8	8	8	8	8
HP	Max Traction Load (N)	5190	6920	11245	18210	24580	40530	11245
	Breaking Strength (N)	20760	27680	44980	69200	93420	141860	44980
	Elongation at MTL (mm/m)	4	4	4	4	4	4	4
Stain-less	Max Traction Load (N)	2865	3585	6095	-	-	-	6095
	Breaking Strength (N)	11475	14345	24385	-	-	-	24385
	Elongation at MTL (mm/m)	3,8	3,8	3,8	-	-	-	3,8

Average values

FLEXION RESISTANCE



	Z_{min}	Z_{min}	Idler min dia (mm)	Z_{min}	Idler min dia (mm)
Standard steel cords	25	28	120	25	80
Kevlar cords	25	28	120	25	100
High Power cords	40	40	160	40	120
Stainless steel cords	32	34	130	32	130

JOINED BELT INFORMATIONS

- Minimum splice length 900 mm
- Traction and tooth resistances = 50% less than open-end
- Joined belt can be used only in conveyor systems
- Rolls with NFT, NFB, and AVAFC can be joined too
- Minimum diameters according above table
- For coated belts, minimum diameters on page 118

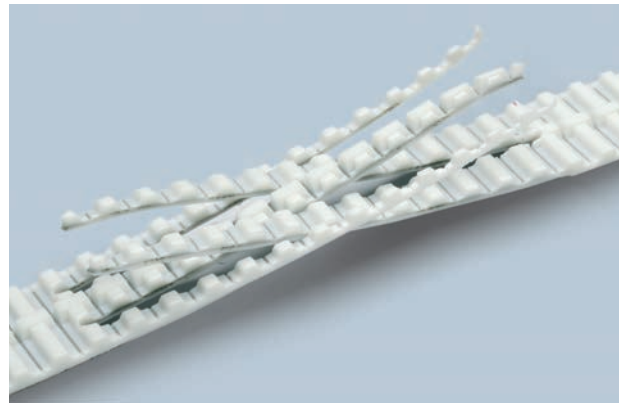

PULLEYS (for more details please see our pulleys catalogue)

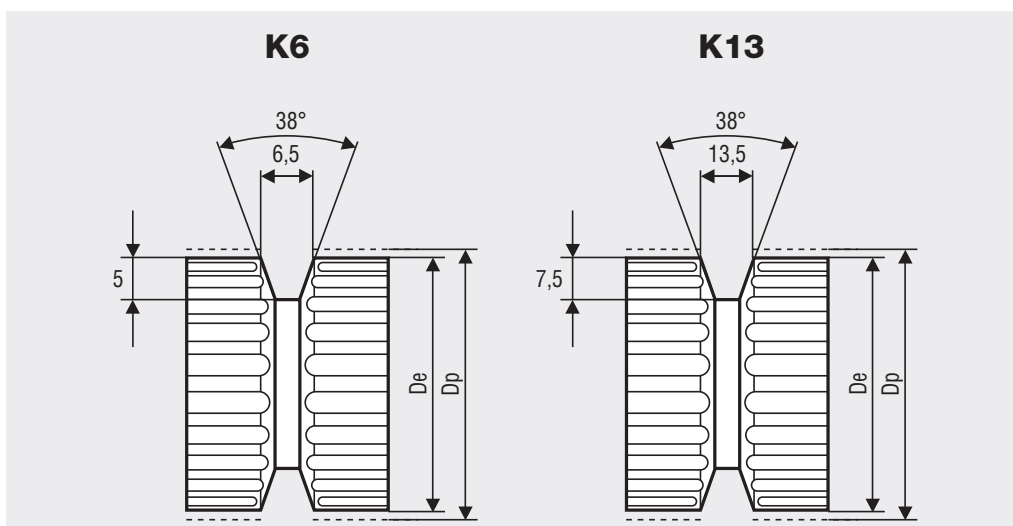

N° Teeth	Dp	De
25	79,58	77,73
27	85,94	84,10
30	95,49	93,65
32	101,86	100,01
36	114,59	112,74
40	127,32	125,48
48	152,79	150,94
60	190,99	189,14

MEGALINEAR ATG20 OPEN-END

BELT CHARACTERISTICS

STANDARD WIDTHS (mm)	75	150
Weight (gr/m)	795	1500

- Standard compound: **white Polyurethane thermoplastic 92 ShA**
- Standard back cover: **none**
- Standard tooth cover: **none**
- Standard cords: **S and Z torsion zinked steel**
- Standard width tolerance: **+/- 1 mm**
- Standard length tolerance: **+/- 0,8 mm/m**
- Standard roll length: **100 m**
- Belt options on request with minimum quantity:
 - Nylon fabric back
 - Nylon fabric teeth*
 - Antistatic nylon fabric
 - Transparent FDA compound
 - AVAFC 60/70/85 ShA
 - Cleats

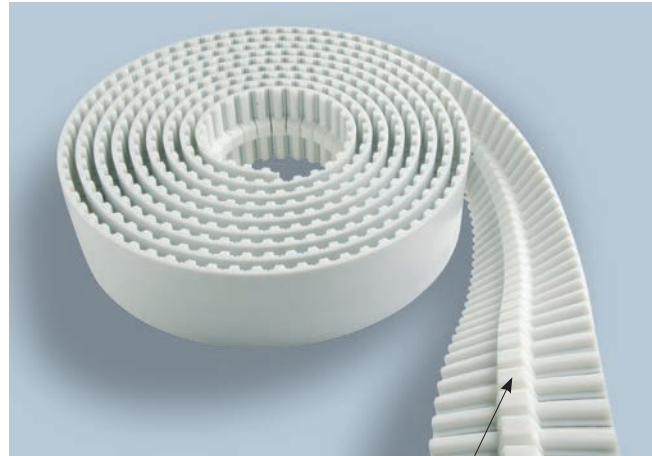

notched guide

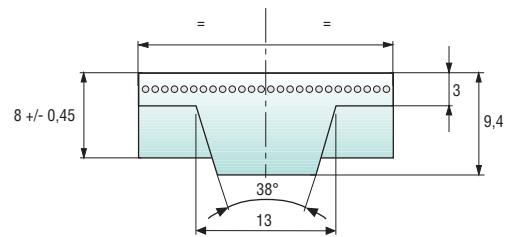

Different back coating materials see page 118

* Nylon fabric teeth excluding guide (2 fabric strips on teeth only).

TOOTH RESISTANCE

RPM (1/min)	0	20	40	60	80	100	200	300	400	500	750	1000	1500	2000	3000	4000	5000
F _{p spec} (N/cm)	147	144	142	139	137	135	126	119	112	107	97	88	76	67	58	43	35

Minimum suggested number of teeth in clamp for linear movement: 7

TRACTION RESISTANCE

Belt width (mm)		75	150
Steel	Max Traction Load (N)	18210	40530
	Breaking Strength (N)	69200	141860
	Elongation at MTL (mm/m)	4	4

Average values

FLEXION RESISTANCE

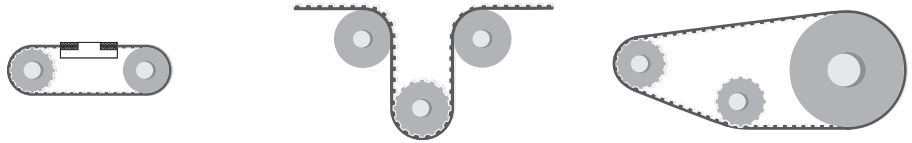

	Z_{min}	Z_{min}	Idler min dia (mm)	Z_{min}	Idler min dia (mm)
Standard steel cords	30	34	180	30	160

JOINED BELT INFORMATIONS

- Minimum splice length 900 mm
- Traction and tooth resistances = 50% less than open-end
- Joined belt can be used only in conveyor systems
- Rolls with NFT, NFB, and AVAFC can be joined too
- Minimum diameters according above table
- For coated belts, minimum diameters on page 118

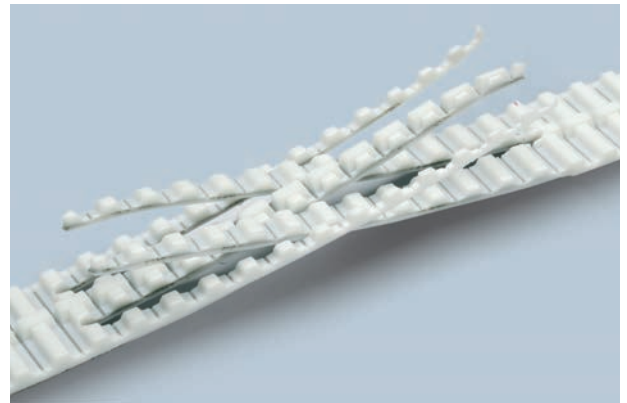

PULLEYS (for more details please see our pulleys catalogue)

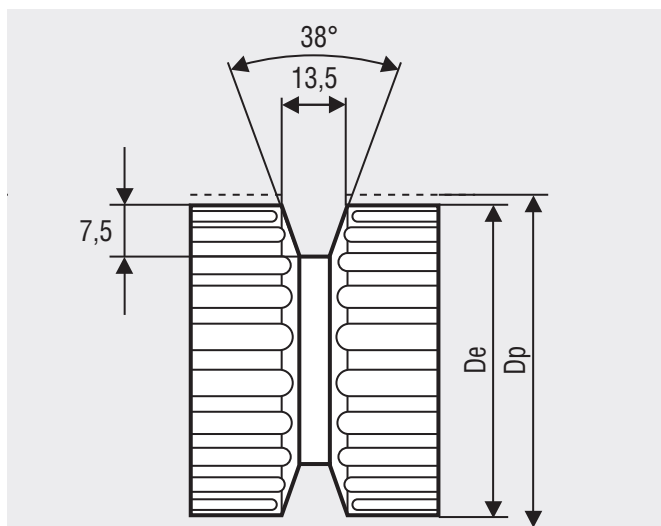

N° Teeth	Dp	De	N° Teeth	Dp	De
30	190,99	188,13	40	254,65	251,80
32	203,72	200,86	48	305,58	302,73
36	229,18	226,33	60	381,97	379,12

MEGALINEAR QST5 OPEN-END

BELT CHARACTERISTICS

STANDARD WIDTHS (mm)	12	24
Weight (gr/m)	60	120

- Standard compound: **white Polyurethane thermoplastic 92 ShA**
- Standard back cover: **none**
- Standard tooth cover: **nylon fabric (NFT)**
- Standard cords: **S and Z torsion zinked steel**
- Standard width tolerance: **-/+ 0,5 mm**
- Standard length tolerance: **-/+ 0,5 mm/m**
- Standard roll length: **100 m**
- Standard thickness tolerance: **-/+ 0,2**

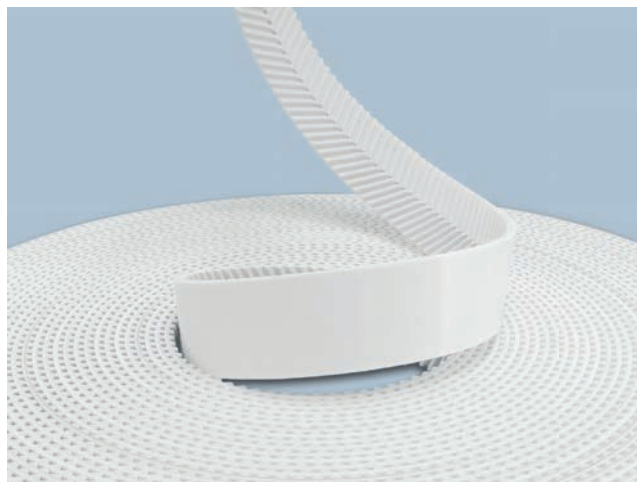

Different back coating materials see page 118
Please ask the feasibility to customer service or OEM team.

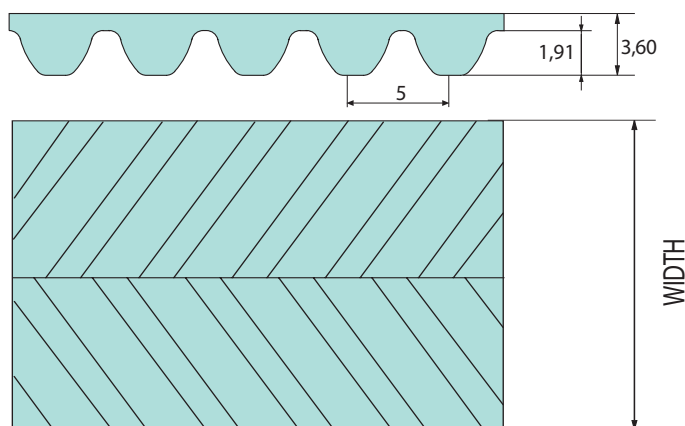

TOOTH RESISTANCE

RPM (1/min)	0	20	40	60	80	100	200	300	400	500	750
$F_{p\ spec}$ (N/cm)	38	37	37	36	36	35	34	33	32	31	30
RPM (1/min)	1000	1250	1500	1750	2000	2500	3000	3500	4000	5000	8000
$F_{p\ spec}$ (N/cm)	28	27	26	25	24	22	21	19	19	17	11

Minimum suggested number of teeth in clamp for linear movement: 7

TRACTION RESISTANCE

Belt width (mm)		12	24
Steel	Max Traction Load (N)	1135	2497
	Breaking Strength (N)	4200	9240
	Elongation at MTL (mm/m)	4	4

Average values

FLEXION RESISTANCE

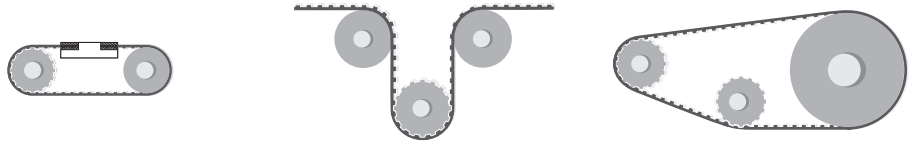

	Z_{min}	Z_{min}	Idler min dia (mm)	Z_{min}	Idler min dia (mm)
Standard steel cords	16	25	60	16	30

JOINED BELT INFORMATIONS

- Minimum splice length 900 mm
- Traction and tooth resistances = 50% less than open-end
- Joined belt can be used only in conveyor systems
- Rolls with NFT, NFB, and AVAFC can be joined too
- Minimum diameters according above table
- For coated belts, minimum diameters on page 118

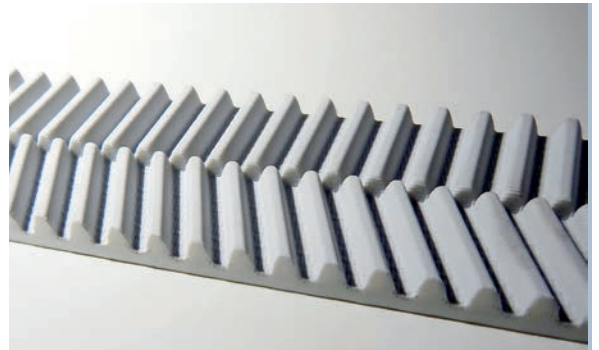

PULLEYS

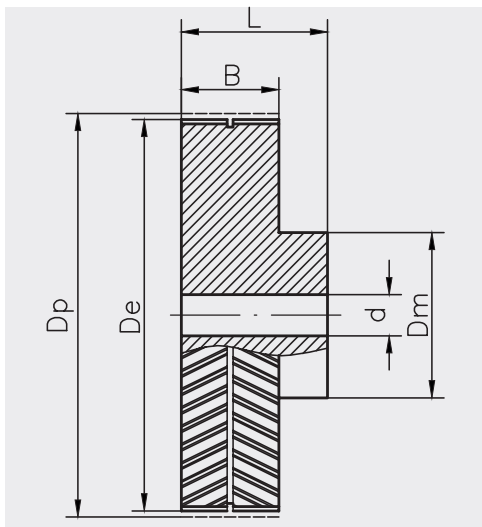

N° Teeth	Dp	De	N° Teeth	Dp	De
16	25,46	24,32	30	47,75	46,60
18	28,65	27,50	32	50,93	49,79
20	31,83	30,69	36	57,30	56,15
21	33,42	32,28	40	63,66	62,52
22	35,01	33,87	44	70,03	68,89
24	38,20	37,05	48	76,39	75,25
26	41,38	40,24	60	95,49	94,35
28	44,56	43,42	72	114,59	113,45

MEGALINEAR QST8 OPEN-END

BELT CHARACTERISTICS

STANDARD WIDTHS (mm)	16	25	32	50
Weight (gr/m)	85	145	180	300

Standard compound: **white Polyurethane thermoplastic 92 ShA**
 Standard back cover: **none**
 Standard tooth cover: **nylon fabric (NFT)**
 Standard cords: **S and Z torsion zinked steel**
 Standard width tolerance: **-/+ 0,5 mm**
 Standard length tolerance: **-/+ 0,8 mm/m**
 Standard roll length: **100 m**
 Standard thickness tolerance: **-/+ 0,3**

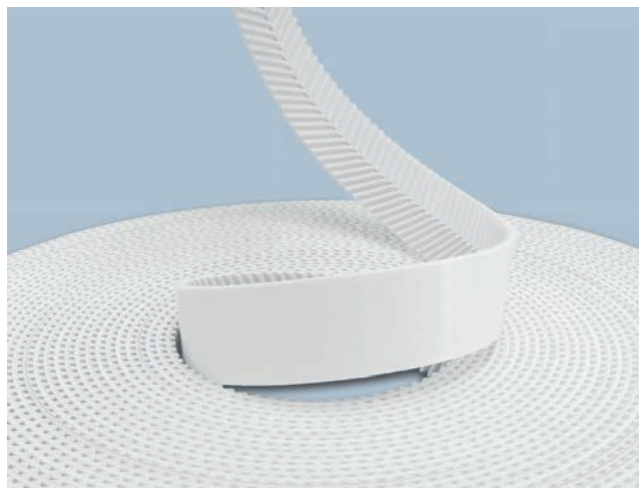

Different back coating materials see page 118
 Please ask the feasibility to customer service or OEM team

Steel cords

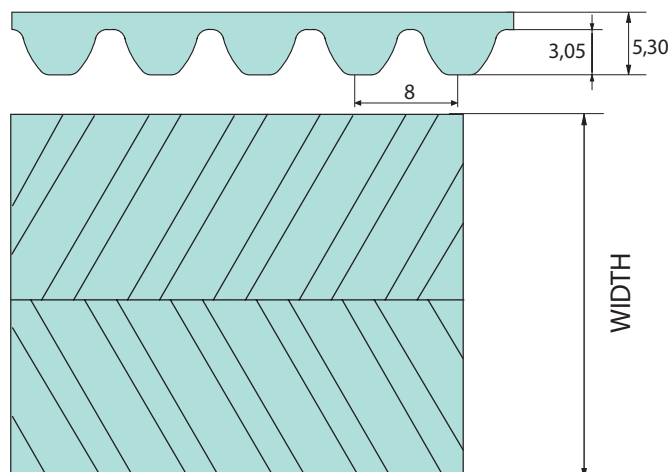

HP

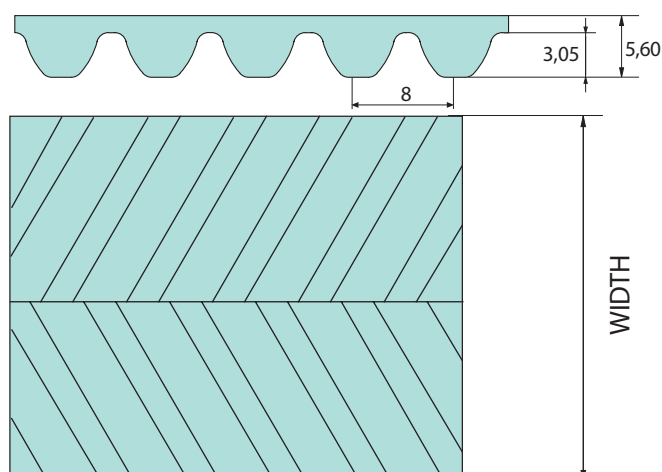

TOOTH RESISTANCE

RPM (1/min)	0	20	40	60	80	100	200	300	400	500	750
F _{p spec} (N/cm)	85	83	82	81	80	79	75	71	68	66	61
RPM (1/min)	1000	1250	1500	1750	2000	2500	3000	3500	4000	5000	8000
F _{p spec} (N/cm)	57	54	51	48	46	43	40	37	35	31	23

Minimum suggested number of teeth in clamp for linear movement: 7-HP cords minimum suggested number of teeth in clamp 10

TRACTION RESISTANCE

Belt width (mm)		16	25	32**	50**
Steel	Max Traction Load (N)	2610	4275	5460	8785
	Breaking Strength (N)	10450	17100	21850	35150
	Elongation at MTL (mm/m)	4	4	4	4
HP	Max Traction Load (N)	3740	6545	8415	14025
	Breaking Strength (N)	13840	24220	31140	51900
	Elongation at MTL (mm/m)	4	4	4	4

Average values

**HP VERSION Under construction

FLEXION RESISTANCE

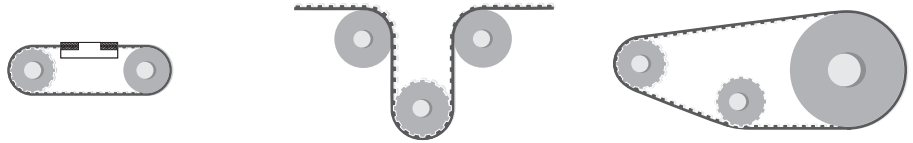

	Z_{min}	Z_{min}	Idler min dia (mm)	Z_{min}	Idler min dia (mm)
Standard steel cords	20	30	120	20	50
High Power cords	30	32	150	30	80

JOINED BELT INFORMATIONS

- Minimum splice length 900 mm
- Traction and tooth resistances = 50% less than open-end
- Joined belt can be used only in conveyor systems
- Rolls with NFT, NFB, and AVAFC can be joined too
- Minimum diameters according above table
- For coated belts, minimum diameters on page 118

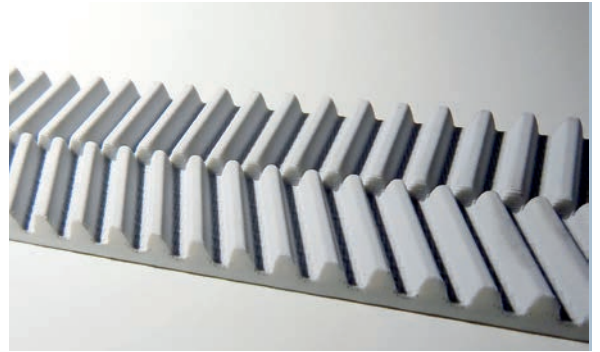

PULLEYS

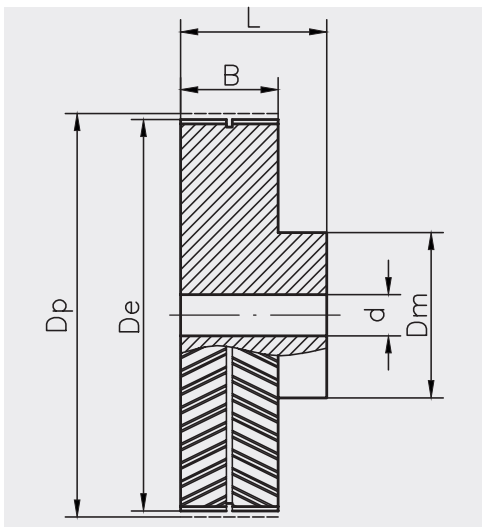

N° Teeth	Dp	De	N° Teeth	Dp	De
18	45,84	44,47	36	91,68	90,30
22	56,02	54,65	38	96,77	95,40
24	61,12	59,75	40	101,86	100,49
26	66,21	64,84	44	112,05	110,68
28	71,30	69,93	48	122,23	120,86
30	76,40	75,03	52	132,42	131,05
32	81,49	80,12	60	152,79	151,42
34	86,58	85,21			

MEGALINEAR QST14 OPEN-END

BELT CHARACTERISTICS

STANDARD WIDTHS (mm)	35	52,5	70	105
Weight (gr/m)	400	600	800	1200

- Standard compound: **white Polyurethane thermoplastic 92 ShA**
- Standard back cover: **none**
- Standard tooth cover: **nylon fabric (NFT)**
- Standard cords: **S and Z torsion zinked steel**
- Standard width tolerance: **-/+ 1 mm**
- Standard length tolerance: **-/+ 0,8 mm/m**
- Standard roll length: **100 m**
- Standard thickness tolerance: **-/+ 0,4**

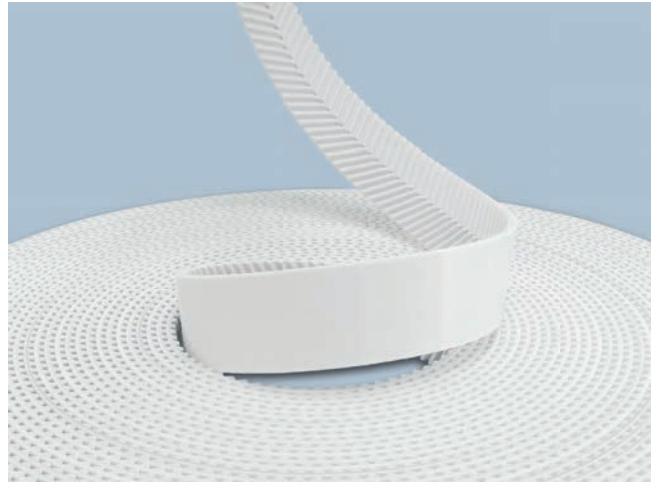

Different back coating materials see page 118
Please ask the feasibility to customer service or OEM team

Steel cords

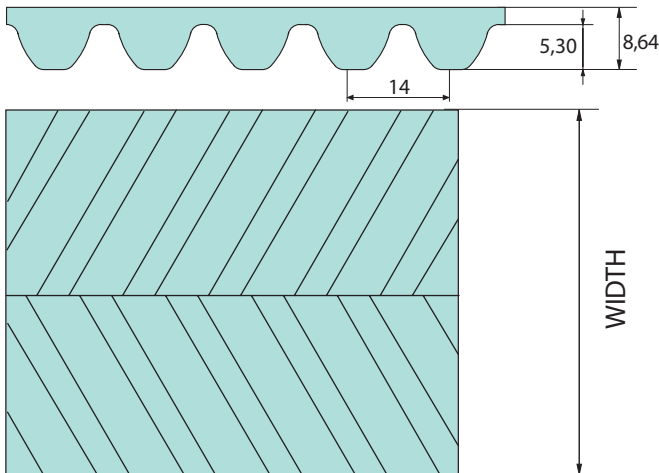

XHP cords

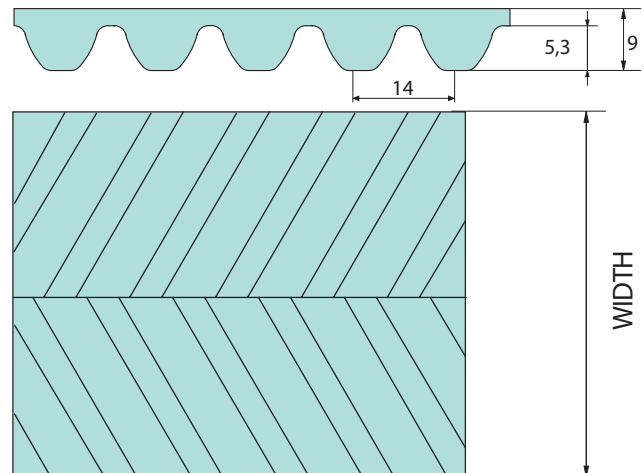

TOOTH RESISTANCE

RPM (1/min)	0	20	40	60	80	100	200	300	400	500	750
$F_{p\ spec}$ (N/cm)	160	157	154	152	149	147	137	130	122	117	105
RPM (1/min)	1000	1250	1500	1750	2000	2500	3000	3500	4000		
$F_{p\ spec}$ (N/cm)	96	89	83	77	72	64	57	50	47		

Minimum suggested number of teeth in clamp for linear movement: 7- XHP cords minimum suggested number of teeth in clamp 10

TRACTION RESISTANCE

Belt width (mm)		35	52,5	70**	105**
Steel	Max Traction Load (N)	11200	17680	23575	36210
	Breaking Strength (N)	44800	67200	89600	137600
	Elongation at MTL (mm/m)	4	4	4	4
XHP	Max Traction Load (N)	15155	26525	34105	53050
	Breaking Strength (N)	57600	100800	129600	201600
	Elongation at MTL (mm/m)	4	4	4	4
Average values					

**XHP VERSION Under construction

FLEXION RESISTANCE

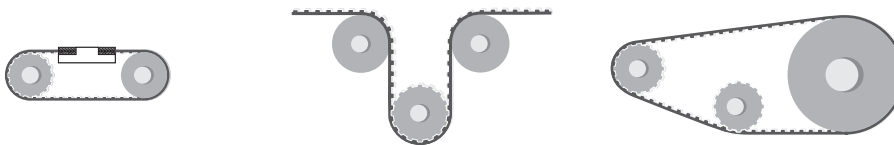

	Z_{min}	Z_{min}	Idler min dia (mm)	Z_{min}	Idler min dia (mm)
Standard steel cords	32	32	200	32	140
Extra high power cords	32	32	200	32	140

JOINED BELT INFORMATIONS

- Minimum splice length 900 mm
- Traction and tooth resistances = 50% less than open-end
- Joined belt can be used only in conveyor systems
- Rolls with NFT, NFB, and AVAFC can be joined too
- Minimum diameters according above table
- For coated belts, minimum diameters on page 118

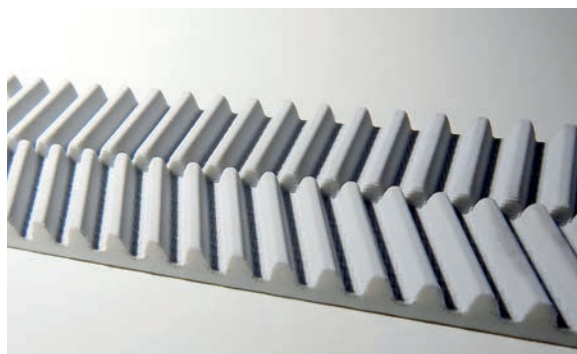

PULLEYS

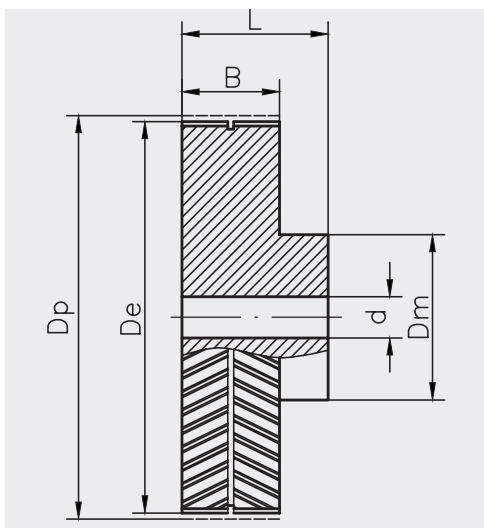

N° Teeth	Dp	De
32	142,61	139,81
34	151,52	148,73
36	160,43	157,64
38	169,35	166,55
40	178,26	175,46
48	213,91	211,12

MEGALINEAR GW14 OPEN-END

BELT CHARACTERISTICS

STANDARD WIDTHS (mm)	50	100	150	200
Weight (gr/m)	740	1500	2250	3000

Standard compound: **black Polyurethane thermoplastic 96 ShA**
 Standard back cover: **none**
 Standard tooth cover: **nylon fabric (NFT)**
 Standard cords: **S and Z torsion zinked steel**
 Standard width tolerance: **-/+ 1 mm**
 Standard length tolerance: **+0 -0,6 mm/m**
 Standard roll length: **100 m**

Suggestions: this type of belts must be well pre-tensioned.

Different back coating materials see page 118

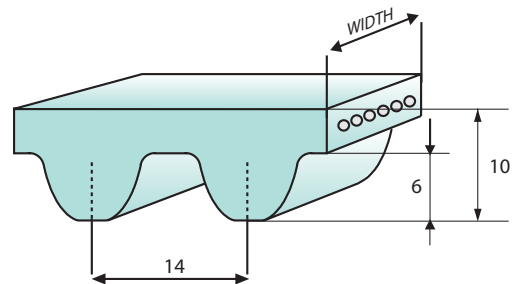
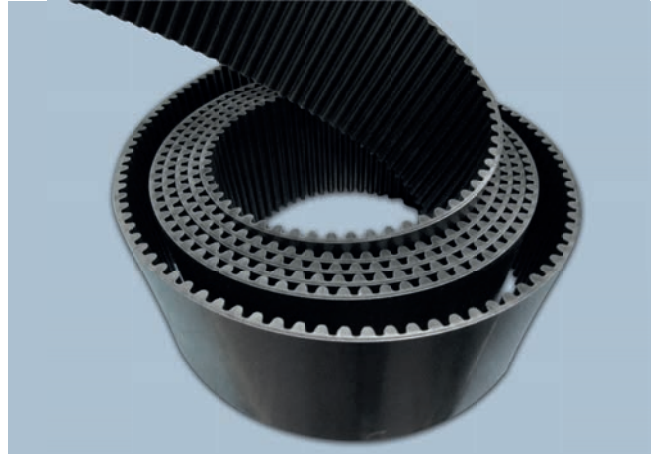

TOOTH RESISTANCE

RPM (1/min)	0	20	40	60	80	100	200	300	400	500
$F_{p\ spec}$ (N/cm)	155	152	149	147	145	142	131	123	116	112

Linear speed over 7m/s, please contact our technical department

Minimum suggested number of teeth in clamp for linear movement: 13

TRACTION RESISTANCE

Belt width (mm)		50	100	150	200
Steel	Max Traction Load (N)	28400	60600	92800	123100
	Breaking Strength (N)	108000	230400	352800	468000
	Elongation at MTL (mm/m)	5,5	5,5	5,5	5,5

Average values

FLEXION RESISTANCE

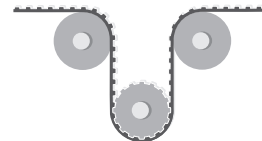
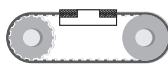

	Z_{min}	Z_{min}	Idler min dia (mm)
Standard steel cords	32	36	250

TYPICAL BELT APPLICATION - AUTOMATIC WAREHOUSE



PULLEYS Suggestions: material steel.- Use only pulley with gw profile. – Flanges 3,5mm fixed with screws.
 B2= belt's width+16 mm.

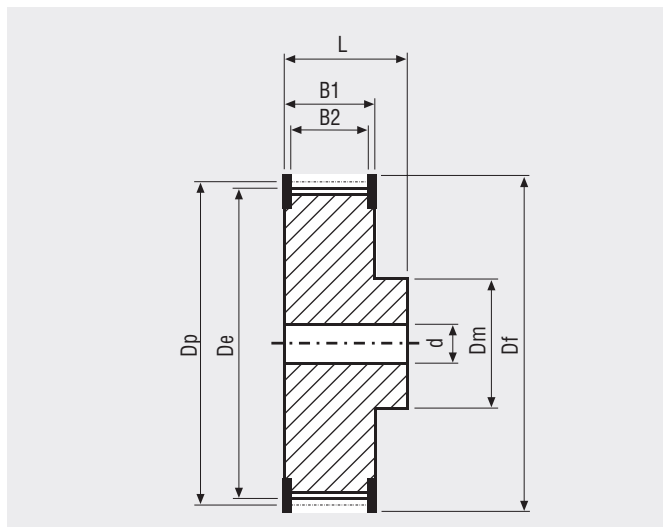

N° Teeth	Dp	De
32	142,60	139,80
34	151,52	148,72
36	160,43	157,63
38	169,34	166,54
40	178,25	175,45
44	196,08	193,28
48	213,90	211,10
56	249,56	246,76
64	285,21	282,41
72	320,86	318,06
80	356,51	353,71
90	401,07	398,27

MEGALINEAR GW20 OPEN-END

BELT CHARACTERISTICS

STANDARD WIDTHS (mm)	50	100	150	200
Weight (gr/m)	1050	2030	3040	4060

- Standard compound: **black Polyurethane thermoplastic 96 ShA**
- Standard back cover: **none**
- Standard tooth cover: **nylon fabric (NFT)**
- Standard cords: **S and Z torsion zinked steel**
- Standard width tolerance: **-/+ 2 mm**
- Standard thickness : **14,3 +/- 0,6 mm**
- Standard length tolerance: **+0 - 1,6mm/m**
- Standard roll length: **100 m**

Suggestions: this type of belts must be well pre-tensioned.

Different back coating materials see page 118

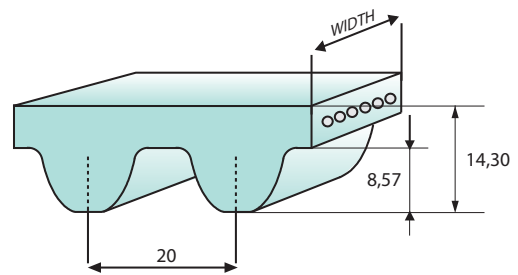
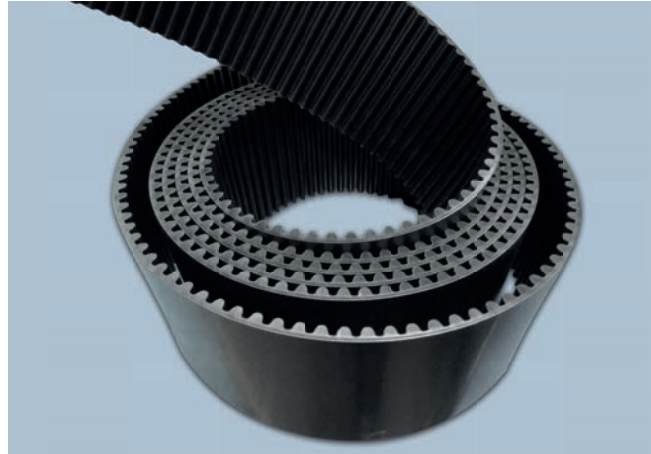

TOOTH RESISTANCE

RPM (1/min)	0	20	40	60	80	100	200	300	400	500
$F_{p\ spec}$ (N/cm)	210	207	198	192	187	182	168	158	150	144

Linear speed over 7m/s, please contact our technical department

Minimum suggested number of teeth in clamp for linear movement: 15

TRACTION RESISTANCE

Belt width (mm)		50	100	150	200
Steel	Max Traction Load (N)	37900	78900	120000	161000
	Breaking Strength (N)	144000	300000	456000	612000
	Elongation at MTL (mm/m)	5,5	5,5	5,5	5,5

Average values

FLEXION RESISTANCE

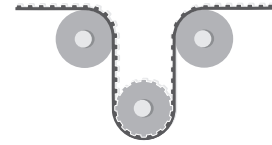
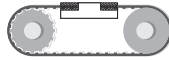

	Z_{min}	Z_{min}	Idler min dia (mm)
Standard steel cords	38	44	380

TYPICAL BELT APPLICATION - AUTOMATIC WAREHOUSE



PULLEYS Suggestions: material steel.- Use only pulley with gw profile. – Flanges 3,5mm fixed with screws.
B2= belt's width+16 mm.

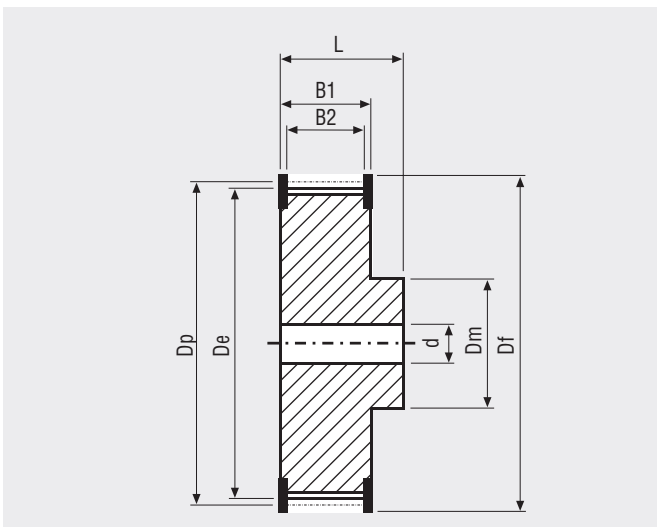

N° Teeth	Dp	De
38	241,92	237,60
40	254,65	250,33
44	280,11	275,79
48	305,58	301,26
56	356,51	352,19
64	407,44	403,12
72	458,37	454,05
80	509,30	504,98

MEGALINEAR FLAT OPEN-END

BELT CHARACTERISTICS

	10 P1	20 P1	25 P2	50 P2	75 P2	100 P2
Weight (gr/m)	20	40	135	245	370	490
Polyurethane 92 ShA	blue	blue	white	white	white	white
Width tolerance(mm)	10 +/-0,5	20 +/-0,5	25 +/-0,5	50 +/-0,5	75 +/-0,5	100 +/-0,5
Thickness (mm)	1+/-0,1	1+/-0,1	2+/-0,2	2+/-0,2	2+/-0,2	2+/-0,2
Gap	Straight	Straight	Straight	Straight	Straight	Straight

	30 P3	60 P3	100 P3	120 P3	25 P4	50 P4	100 P4
Weight (gr/m)	213	426	710	852	220	445	890
Polyurethane 92 ShA	black	black	black	black	transparent	transparent	transparent
Width (mm)	30 +/-0,5	60 +/-0,5	100 +/-0,5	120 +/-0,5	25 +/-0,5	50 +/-0,5	100 +/-0,5
Thickness (mm)	3,2+/-0,2	3,2+/-0,2	3,2+/-0,2	3,2+/-0,2	4+0,4/-0	4+0,4/-0	4+0,4/-0
Gap	Helical	Helical	Helical	Helical	Straight	Straight	Straight

Standard back cover: **none**
 Standard tooth cover: **none**
 Standard cords: **S and Z torsion zinked steel**
 Standard roll length: **100 m**
 Belt options on request with minimum quantity:
 Nylon fabric back
 Nylon fabric teeth
 Antistatic nylon fabric
 No gap
 Silicon free compound
 Special thickness tolerances by grinding (suggested for applications with rolled belts)

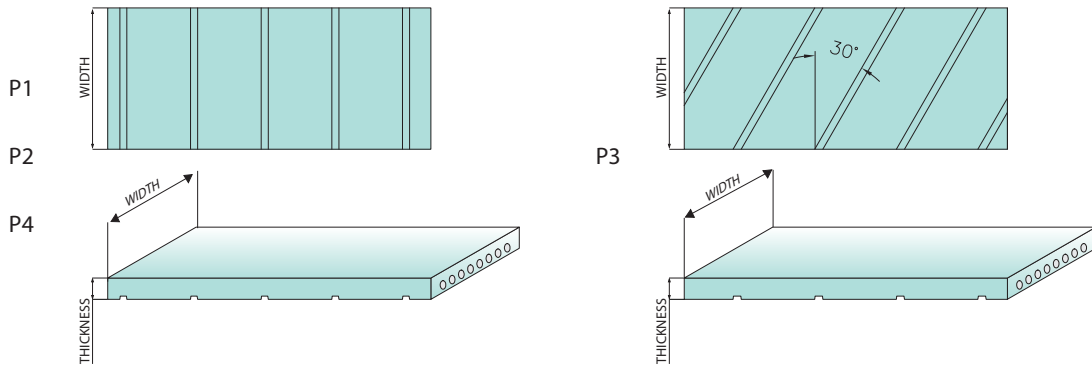

TRACTION RESISTANCE

	Belt width (mm)	10 P1	20 P1	25 P2	50 P2	75 P2	100 P2
Steel	Max Traction Load (N)	490	980	3800	8075	13000	17500
	Breaking Strength (N)	1965	3935	15200	32300	49400	66500
	Elongation at MTL (mm/m)	4	4	4	4	4	4
HP	Max Traction Load (N)	-	-	5190	11245	18210	24580
	Breaking Strength (N)	-	-	20760	44980	69200	93420
	Elongation at MTL (mm/m)	-	-	4	4	4	4

	Belt width (mm)	30 P3	60 P3	100 P3	120 P3	25 P4	50 P4	100 P4
Steel	Max Traction Load (N)	9120	19200	32000	42560	8000	16000	34525
	Breaking Strength (N)	36480	72960	121600	148960	32000	64000	131200
	Elongation at MTL (mm/m)	4	4	4	4	4	4	4

FLEXION RESISTANCE



	Driver pulley min dia (mm)	Driver pulley min dia (mm)	Idler min dia (mm)
Standard steel cords P1	16	25	30
Standard steel cords P2	45	50	90
High Power cords P2	56	62	150
Standard steel cords P3	100	110	150
Standard steel cords P4	100	110	150

FIXING PLATES

DIMENSION OF THE FIXING PLATES

Belt type	Clamping plates dimensions					Suggested clamping plate width W (mm)								
	L1 (mm)	C (mm)	D (mm)	T (mm)	Rmin (mm)	10	20	25	30	50	60	75	100	120
P1	20	25	16	3	10	20	20	30	-	-	-	-	-	-
P2	25	30	20	3	10	-	-	50	-	75	-	100	-	-
P2 HP	25	30	20	3	10	-	-	50	-	75	-	100	-	-
P3	30	75	50	5	25	-	-	-	60	-	90	-	132	160
P4	30	120	80	7	40	-	-	-	-	75	-	-	125	-

SUGGESTION ABOUT THE FIXING SCREW

Belt type	Kind of screws	Belt width (mm)												
		10	20	25	30	50	60	75	100	120				
P1	M5	4	4	-	-	-	-	-	-	-	-	-	-	-
P2	M6	-	-	4	-	4	-	6	8	-	-	-	-	-
P2 HP	M6	-	-	4	-	6	-	8	10	-	-	-	-	-
P3	M8	-	-	-	4	-	6	-	8	12	-	-	-	-
P4	M10	-	-	4	-	4	-	-	6	-	-	-	-	-

Belt type	Kind of screws	Suggested number of screws												
		10	20	25	30	50	60	75	100	120				
P1	M5	4	4	-	-	-	-	-	-	-	-	-	-	-
P2	M6	-	-	4	-	4	-	6	8	-	-	-	-	-
P2 HP	M6	-	-	4	-	6	-	8	10	-	-	-	-	-
P3	M8	-	-	-	4	-	6	-	8	12	-	-	-	-
P4	M10	-	-	4	-	4	-	-	6	-	-	-	-	-

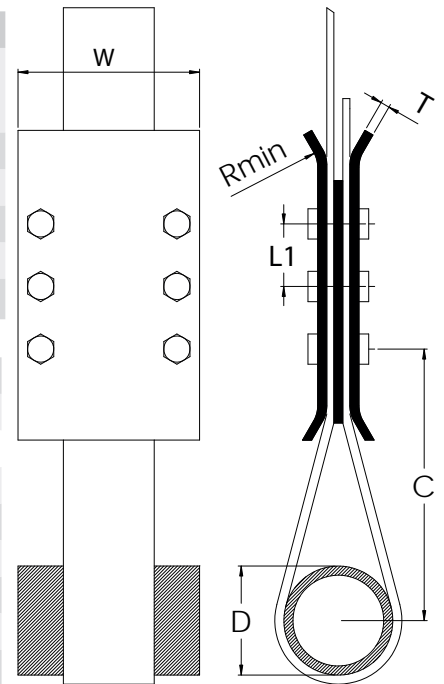

PULLEYS

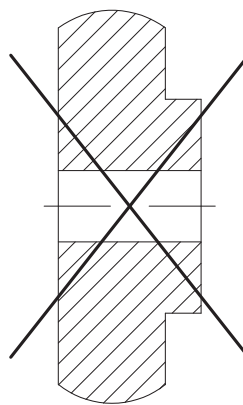
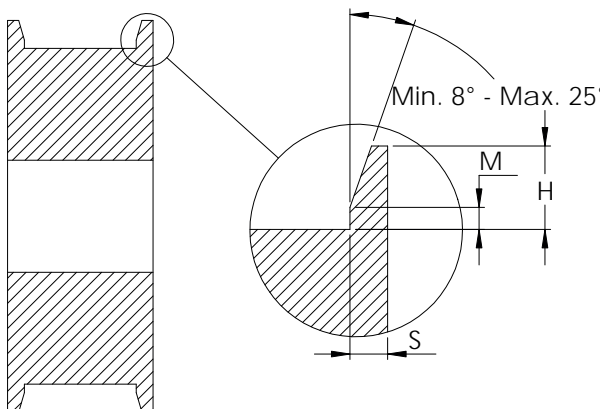

Suggested material: Aluminium or Zinked steel
Maximum superficial roughness: 1.6 Ra

Flanges according the table

Belt type	S (mm)	M (mm)	H (mm)
P1	1,5	0,4+0,3/0	2,1+0,25/0
P2	2,3	0,4+0,3/0	2,1+0,25/0
P2 HP	2,3	0,4+0,3/0	2,1+0,25/0
P3	3	0,9+0,5/0	5+0,25/0
P4	3	0,9+0,5/0	5+0,25/0

H: minimum height of flanges
S: minimum thickness of flanges
Rounded corner not quoted R = 0,8 mm

MEGALINEAR FC T5

T 5						
STANDAR WIDTHS (mm)	25	32	50	75	100	150
Width tolerance(mm)	+/- 0,25	+/- 0,25	+/- 0,5	+/- 0,5	+/- 0,75	+/- 0,75

SMOOTH SURFACE

Standard compound:

dark blue Polyurethane thermoplastic 85 ShA

Total Thickness :

2,8 +/- 0,3 mm

Height of the profile:

0 mm

Standard cords:

S and Z torsion Kevlar

Standard roll length:

50 m

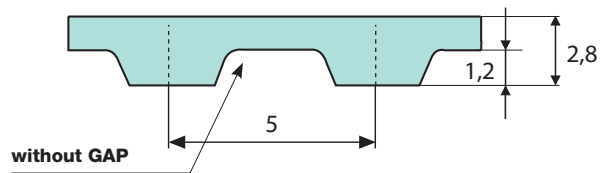
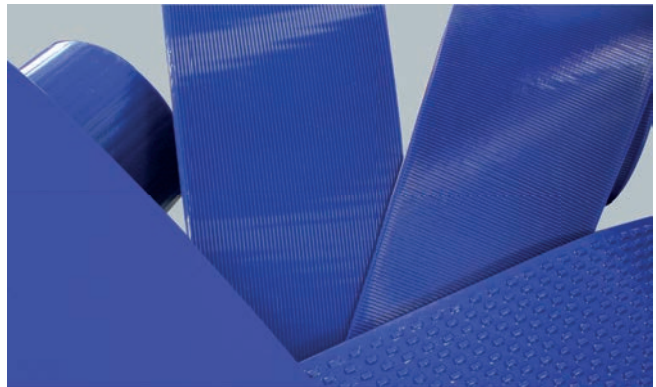
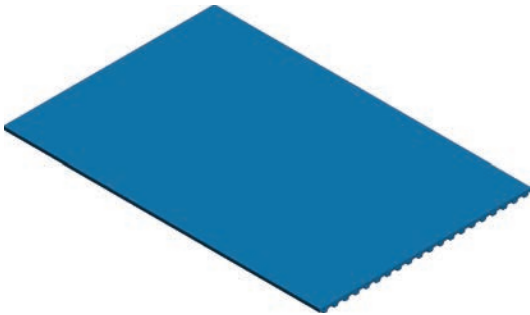

LONGITUDINAL RIBBED SURFACE

Standard compound:

dark blue Polyurethane thermoplastic 85 ShA

Total Thickness :

4,0 +/- 0,3 mm

Height of the profile:

1,25 mm

Standard cords:

S and Z torsion Kevlar

Standard roll length:

50 m

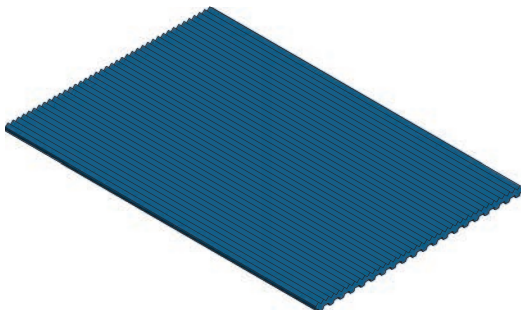

TRANSVERSAL RIBBED SURFACE

Standard compound:

dark blue Polyurethane thermoplastic 85 ShA

Total Thickness :

4,0 +/- 0,3 mm

Height of the profile:

1,25 mm

Standard cords:

S and Z torsion Kevlar

Standard roll length:

50 m

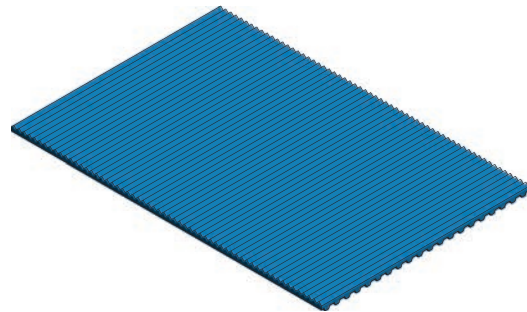

NOPPEN OVAL SURFACE

Standard compound:

dark blue Polyurethane thermoplastic 85 ShA

Total Thickness :

5,2 +/- 0,3 mm

Height of the profile:

2,1mm

Standard cords:

S and Z torsion Kevlar

Standard roll length:

50 m

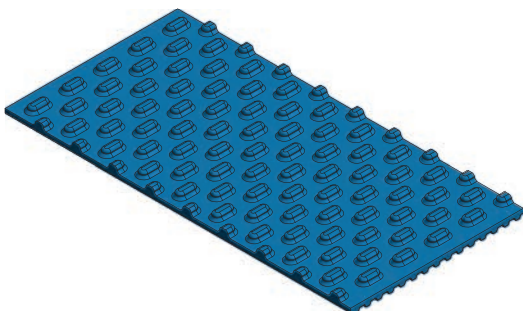

T 10						
STANDAR WIDTHS (mm)	25	32	50	75	100	150
Width tolerance(mm)	+/- 0,25	+/- 0,25	+/- 0,5	+/- 0,5	+/- 0,75	+/- 0,75

SMOOTH SURFACE

Standard compound:

dark blue Polyurethane thermoplastic 85 ShA

Total Thickness :

4,8 +/- 0,3 mm

Height of the profile:

0 mm

Standard cords:

S and Z torsion Kevlar

Standard roll length:

50 m

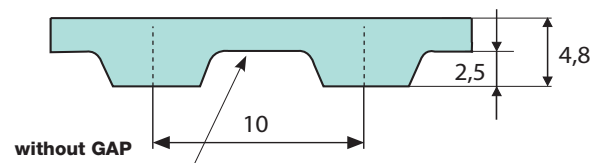
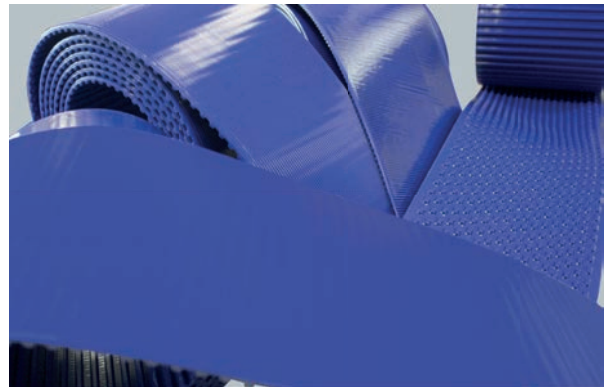
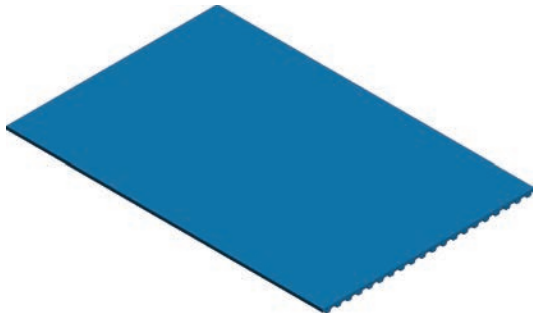

LONGITUDINAL RIBBED SURFACE

Standard compound:

dark blue Polyurethane thermoplastic 85 ShA

Total Thickness :

6,05 +/- 0,3 mm

Height of the profile:

1,25 mm

Standard cords:

S and Z torsion Kevlar

Standard roll length:

50 m

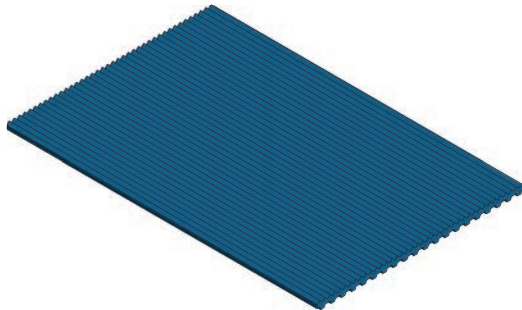

TRANSVERSAL RIBBED SURFACE

Standard compound:

dark blue Polyurethane thermoplastic 85 ShA

Total Thickness :

6,05 +/- 0,3 mm

Height of the profile:

1,25 mm

Standard cords:

S and Z torsion Kevlar

Standard roll length:

50 m

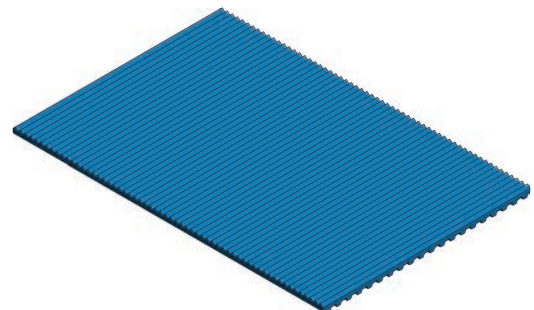

NOPPEN OVAL SURFACE

Standard compound:

dark blue Polyurethane thermoplastic 85 ShA

Total Thickness :

7,7 +/- 0,3 mm

Height of the profile:

2,1 mm

Standard cords:

S and Z torsion Kevlar

Standard roll length:

50 m

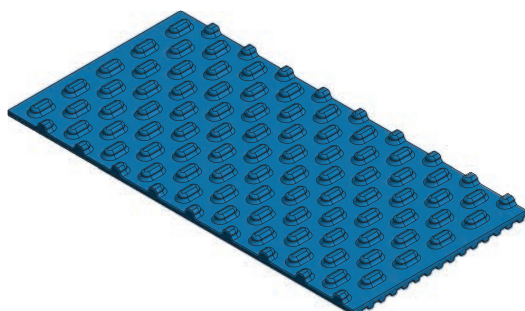

ROOF SURFACE

Standard compound:

dark blue Polyurethane thermoplastic 85 ShA

Total Thickness :

6,2 +/- 0,3 mm

Height of the profile:

1,7 mm

Standard cords:

S and Z torsion Kevlar

Standard roll length:

50 m

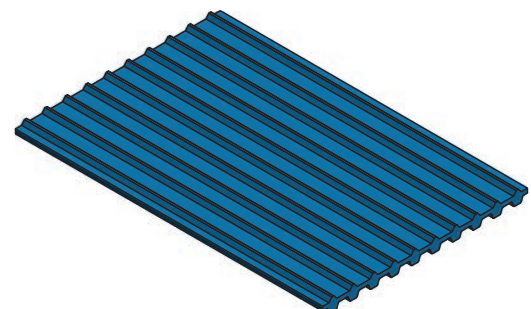

FIXING PLATES

The fixing plates are used to fix the tail of the open belts.

On the customer's request, the plates can be delivered with or without fixing holes.

As the belt can't be stretched with the fixing plates we suggest to use other tension system.

The plates are delivered in aluminium alloy.

The Megadyne Technical Staff is ready to study special or particular applications.

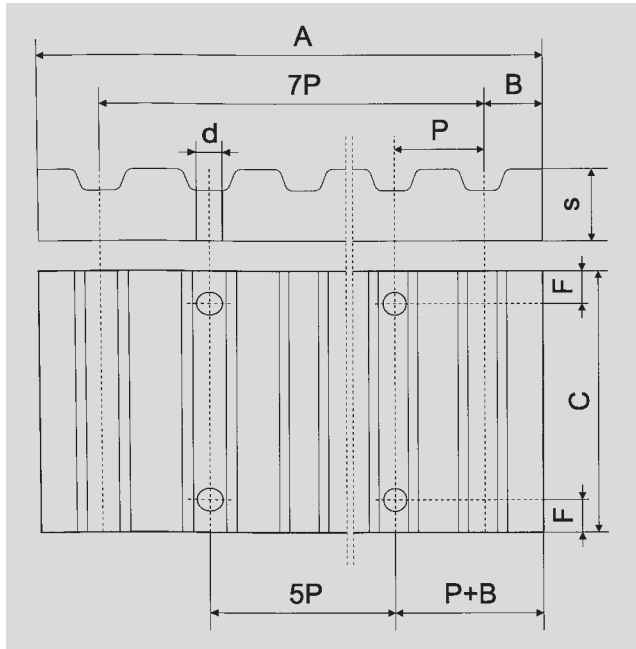

XL - L - H - T5 - T10 - T20 - AT5 - AT10 - AT20

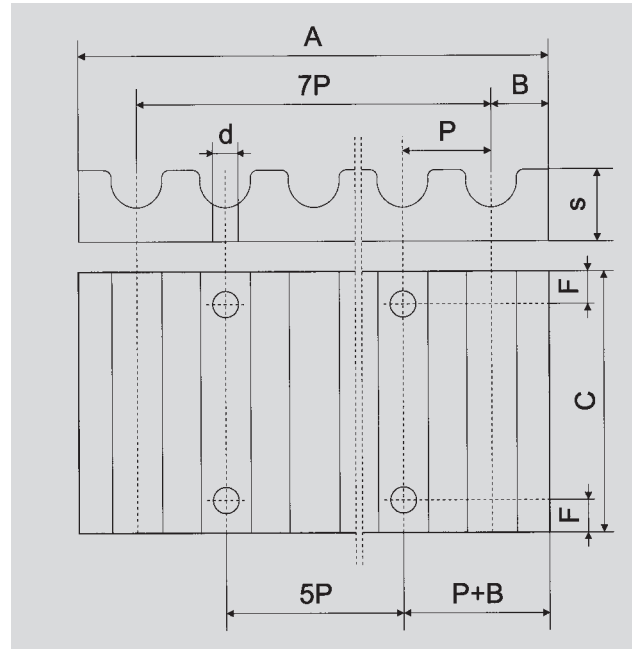

HTD

Order code example: AT10 pitch clamping plate for 25 mm width belt.

		Clamping plates for imperial pitch belts													
								Belt width (inches)							
Aluminium	Pitch	F	d	B	A	S	025	037	050	075	100	150	200	300	400
	C														
•XL	6	5,5	3,5	42,5	8	25,5	28,5	32	38	45	-	-	-	-	-
•L	8	9	5	76,5	15	-	-	39	45	51,5	64	77	-	-	-
•H	10	11	9	106,9	22	-	-	45	51	57,5	70	83	108	134	-

		Clamping plates for HTD pitch belts																	
								Belt width (mm)											
Aluminium	Pitch	F	d	B	A	S	6	9	10	15	20	25	30	40	50	55	85	115	170
	C																		
•5M	6	5,5	3,25	41,5	8	25	28	-	34	-	44	-	-	-	-	-	-	-	-
•8M	8	9	5	66	15	-	-	35	40	45	-	55	-	75	-	110	-	-	-
•14M	10	11	9	116	22	-	-	-	-	-	56	-	71	-	86	116	146	201	-

		Clamping plates for imperial pitch belts													
								Belt width (inches)							
Aluminium	Pitch	F	d	B	A	S	6	10	16	20	25	32	50	75	100
	C														
•T5	6	5,5	3,25	41,65	8	25	29	35	39	44	51	69	-	-	-
•AT5						-	-	-	-	-	-	-	-	-	-
•T10	8	9	5	80	15	-	35	41	-	50	57	75	100	125	-
•AT10						-	-	-	-	-	-	-	-	-	-
•T20	10	11	10	160	20	-	-	-	-	56	63	81	106	132	-
•AT20						-	-	-	-	-	-	-	-	-	-

• Available in customized length

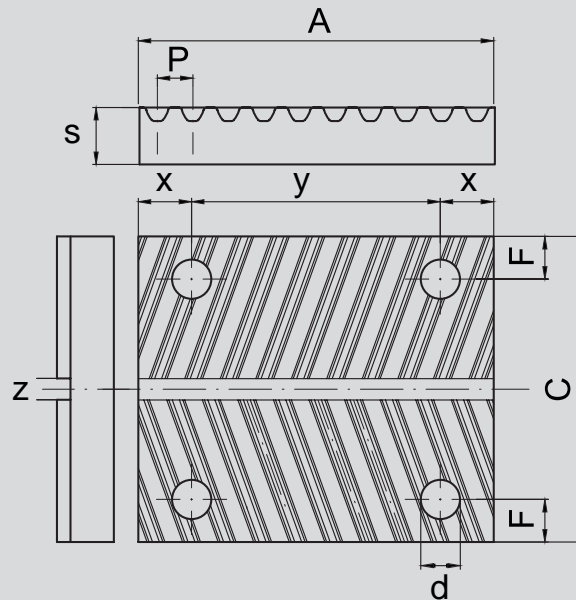

Clamping plates for QST 5

Aluminium	Pitch	BELT'S WIDTH (mm)	F	d	A	S	x	y	z	C
	• QST 5		12	6	5,5	50	8	7,5	35	3
		24	6	5,5	50	8	7,5	35	3	43

Clamping plates for QST 8

Aluminium	Pitch	BELT'S WIDTH (mm)	F	d	A	S	x	y	z	C
	• QST 8		16	7,5	9	74	14,5	13	48	3
		25	8	9	74	14,5	13	48	3	50
		32	8	9	74	14,5	13	48	3	57
		50	8	9	74	14,5	13	48	3	75

Clamping plates for QST 14

Aluminium	Pitch	BELT'S WIDTH (mm)	F	d	A	S	x	y	z	C
	• QST 14		35	9,5	11	130	22	23	84	3
		52,5	9,5	11	130	22	23	84	3	82,5
		70	9,5	11	130	22	23	84	3	100
		105	10	11	130	22	23	84	3	136

• Available in customized length

FIXING PLATES GW

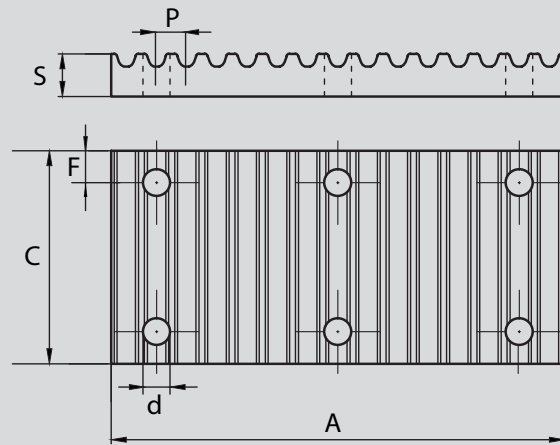

Clamping plates for GW14									
Steel	BELT'S WIDTH (mm)	A (mm)	C (mm)	S (mm)	F (mm)	d (mm)	Screws UNI-EN 14399-8.8	N° of screws	
	Pitch	50	210	100	20	15	12,5	M12	2X3
	• GW14	100	210	150	20	15	12,5	M12	2X3
		150	210	200	20	15	12,5	M12	2X5
		200	210	250	20	15	12,5	M12	2X6

Clamping plates for GW20									
Steel	BELT'S WIDTH (mm)	A (mm)	C (mm)	S (mm)	F (mm)	d (mm)	Screws UNI-EN 14399-8.8	N° of screws	
	Pitch	50	340	110	36	15	16,5	M16	2X3
	• GW20	100	340	160	36	15	16,5	M16	2X3
		150	340	210	36	15	16,5	M16	2X4
		200	340	260	36	15	16,5	M16	2X5

POSITIONING AND TRANSMISSION PRECISION

Backlash between belt and pulley teeth is very important for positioning and transmission synchronism.

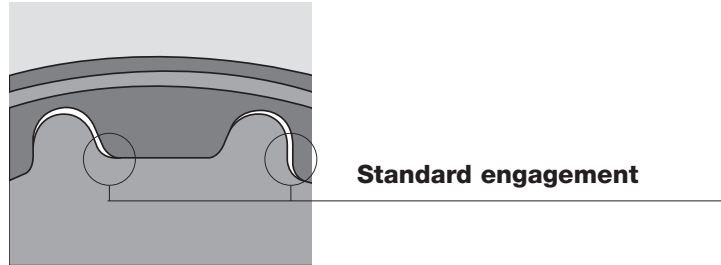

To improve transmission precision, it is possible to use zero or reduced backlash pulleys. Please note that these pulleys don't reduce the elasticity of belt teeth or cords.

Maximum recommend pulley teeth is:

- Till 100 1/min Z = 40
- Till 500 1/min Z = 30
- Till 1000 1/min Z = 20

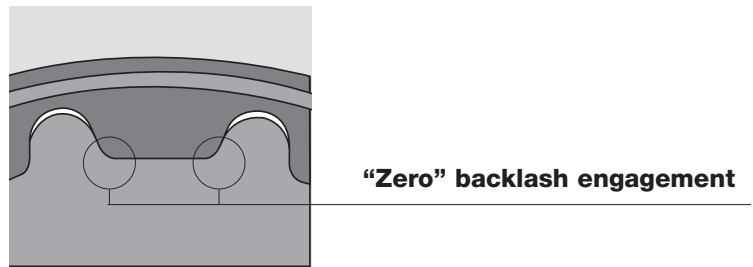

In following table there is a list of average values for backlashes:

Available pitch for "zero" backlash pulley	T5 XL	T10 L H	T20 XH	AT5	AT10	AT20
Average backlash value for standard	0,6	1,2	2,4	0,2	0,4	0,8

RPP belts and pulleys offer great solution for positioning system because their parabolic profile reduces backlash and improves meshing quality.

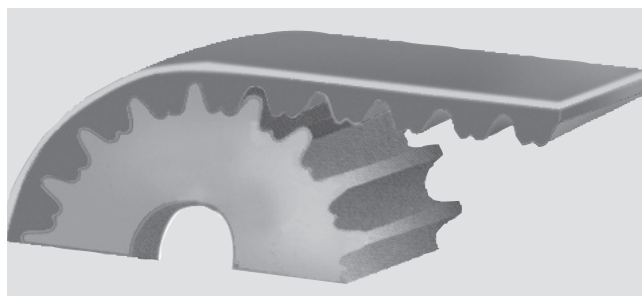

CLEATS

Megadyne timing belts can be customised with profiles vulcanised on the backside. All the cleats are made using the same thermoplastic polyurethane as the MEGALINEAR body (white PU 92 ShA).

The profiles are attached with the best technology now available, the High Vibration System.

The production process for these profiles is very flexible; Megadyne can design any profile to meet the specific requirement of the customer, in order to check and develop all the needed special profiles.

STANDARD PARALLELEPIPED PROFILES

Megadyne can produce, as standard cleats, the parallelepiped profiles, starting from a thermoplastic polyurethane strip roll and cutting until the requested profile dimension.

The t value (thickness) is available from 2 until 13 mm, the h value (height) can be from 3 until 120 mm and the width can be 150 mm maximum.

Megadyne recommend that the profile spacing were multiple of the belt pitch; in any case, for special inquiries and small quantities, it is possible to weld the profiles also in others positions; the feasible dimensions, with the standard process tolerances, are introduced in the following sketch.

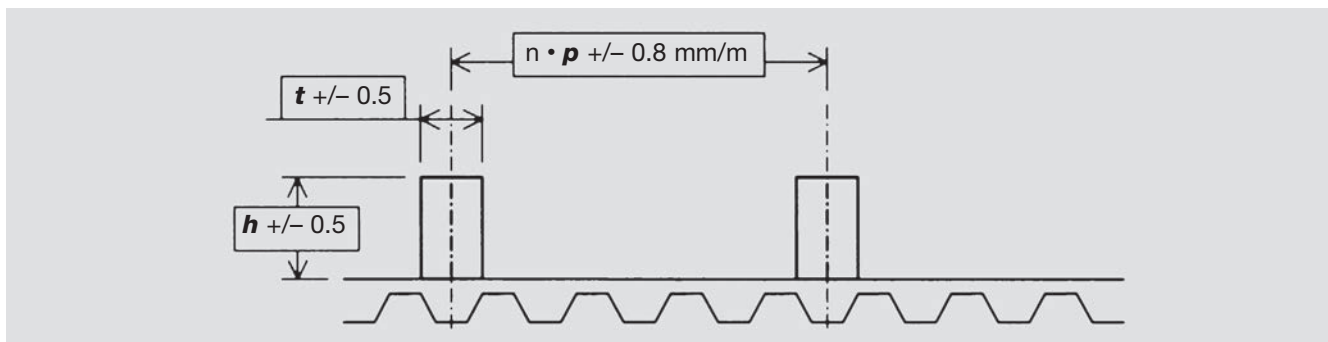

The tolerances on the position are ± 0.5 mm.

The cumulative tolerance on the spacing of the profiles is the same of the length tolerance for our standard belts (± 0.8 mm/m) (tighter tolerances are available on request).

Due to the welding process, a bead of material develops at the meeting point of profile and belt.

In any case, Megadyne always remove this welding bead.

Profile **MECHANICAL RESISTANCE**

In order to find the right cleat dimensions, please consider the following factors:

- Section base cleats resistance (**R**) becomes bigger, increasing:
 - cleats width (**w**)
 - cleats thickness (**t**)

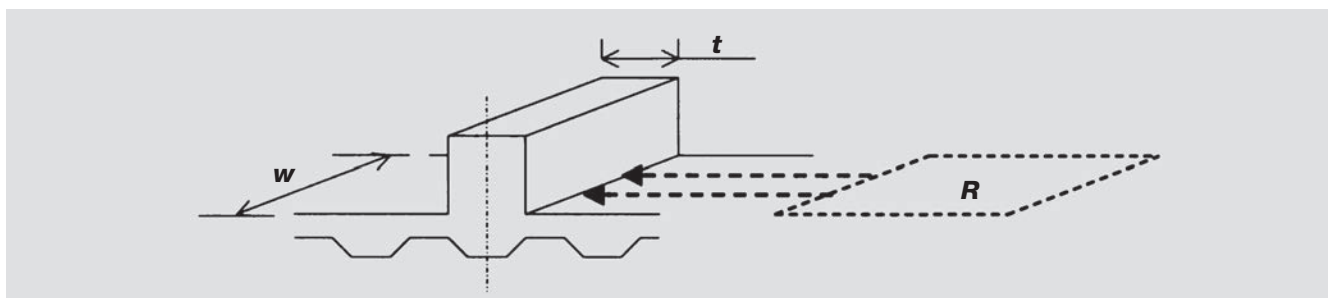



- Cleat stiffness is bigger:
 - increasing cleat thickness (**t**)
 - using special moulded profiles, like STDE0006, STDE0008, STDE0010 and STMI0012 types

MIN. N° OF PULLEY TEETH FOR BELTS WITH PROFILES

The profiles presence can change the belt flexibility properties; the two factors that affect the original flexibility are the following:

- thickness of the cleat “foot“ (size of the base). Flexibility decreases when welded area dimensions increase
- position of the welded profile on the belt. When the cleats are welded in axis with the teeth, belt flexibility is better than when cleats are welded in axis with the little nose.

Please find, in the following table, flexibility properties for the cleated belts.

MINIMUM NUMBER OF PULLEY TEETH													
CLEATS OVER A TOOTH							CLEATS NOT OVER A TOOTH						
													
CLEATS THICKNESS	4	5	6	8	10	12	CLEATS THICKNESS	4	5	6	8	10	12
XL	18	18	25	40	50	100	XL	45	45	50	60	100	-
L	12	12	18	30	40	60	L	40	40	45	55	60	80
H	14	14	14	18	25	45	H	25	25	30	45	50	65
XH	18	18	18	28	18	20	XH	20	20	30	40	45	54
T5 / AT5	18	18	25	40	50	100	T5 / AT5	45	45	50	60	100	-
T10 / AT10	14	14	14	18	25	45	T10 / AT10	30	30	40	45	50	65
T20 / AT20	18	18	18	18	18	20	T20 / AT20	20	20	30	40	45	54
RPP5	18	18	25	40	50	100	RPP5	45	45	50	60	100	-
RPP8	14	14	14	18	25	45	RPP8	30	30	40	45	50	65
RPP14	18	18	18	18	18	20	RPP14	20	20	30	40	45	54

STANDARD PARALLELEPIPED PROFILES WITH HOLES

Parallelepiped profiles are available also with holes, to satisfy specials applications; please find below the standard tolerances for this kind of cleats.

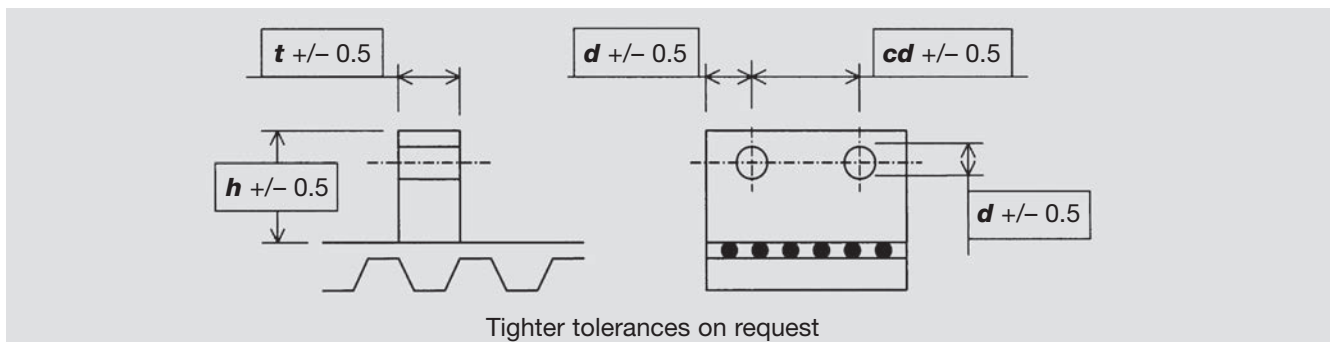

For belt flexibility and mechanical resistance, please kindly refer to values for cleats without holes.

MOULDED CLEATS

Using an high performance injection system, Megadyne can produce any profile designed by the customer. For cleats not yet present in following pages, Megadyne can produce dedicated mould according customer requirements. For belt flexibility and mechanical resistance, please kindly refer to standard parallelepiped profiles section.

CLEATS

If the needed cleat wouldn't yet present in the following tables, please contact MEGADYNE staff.

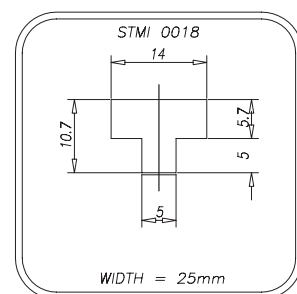
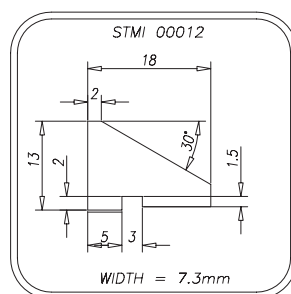
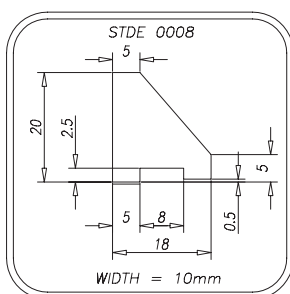
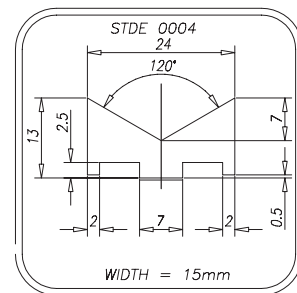
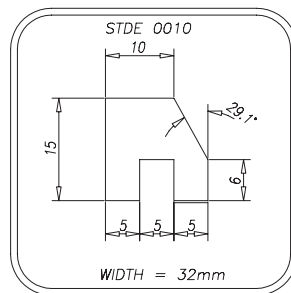
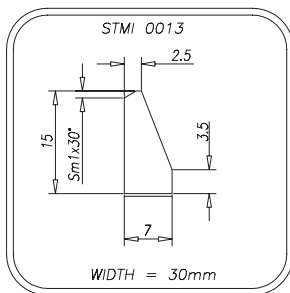
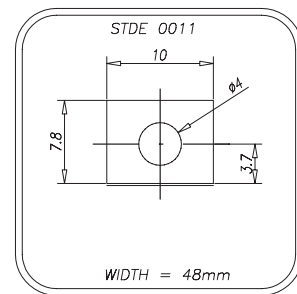
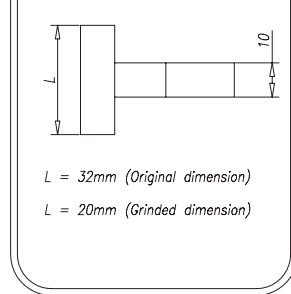
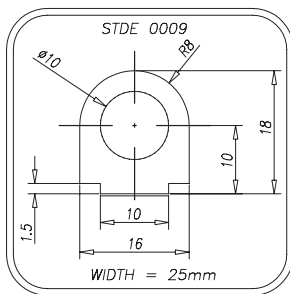
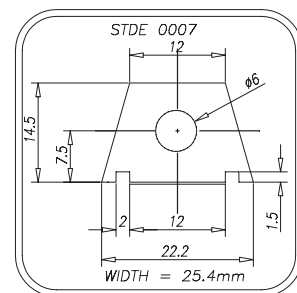
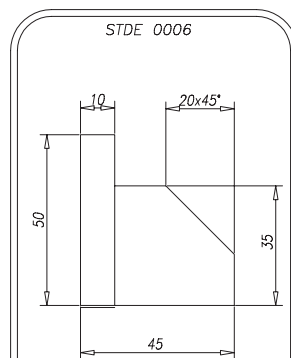
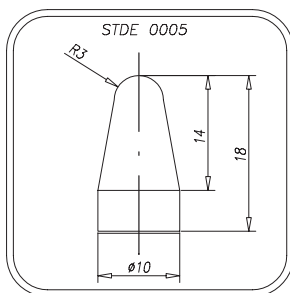
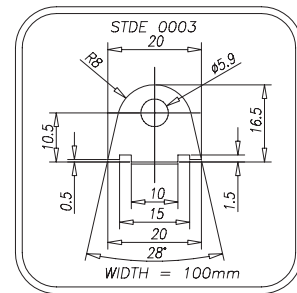
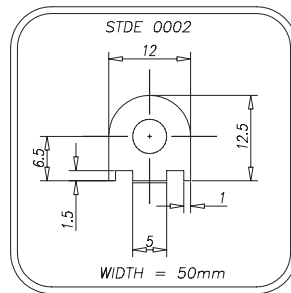
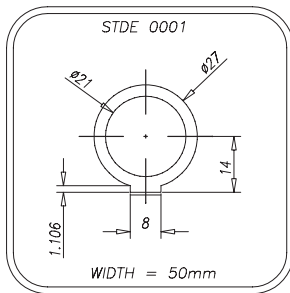

If the needed cleat wouldn't yet present in the following tables, please contact MEGADYNE staff.

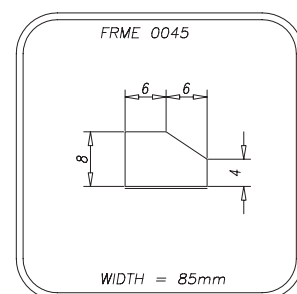
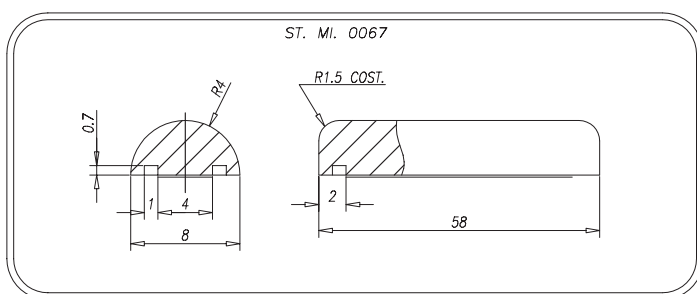
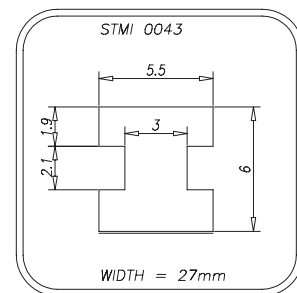
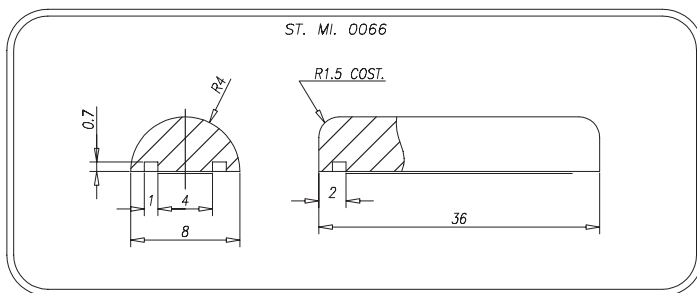
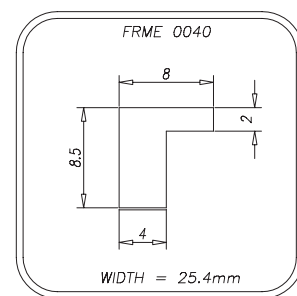
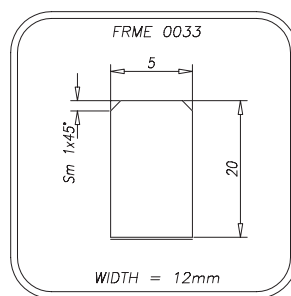
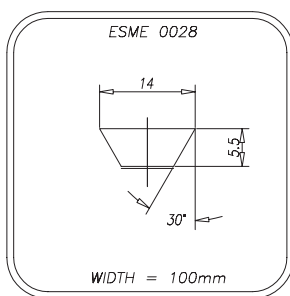
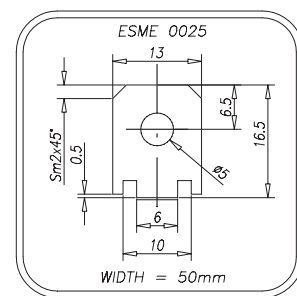
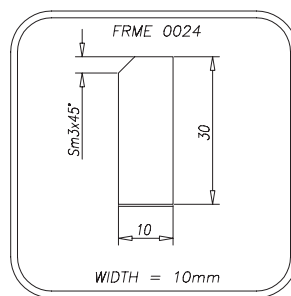
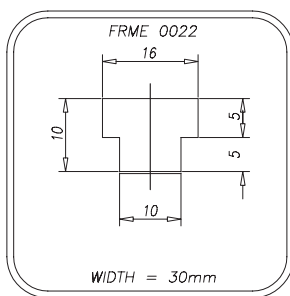
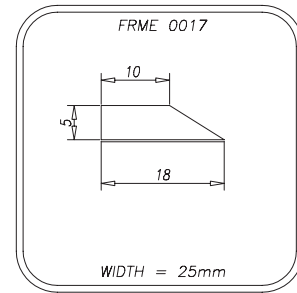
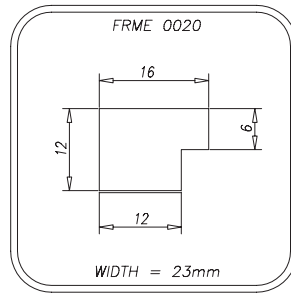
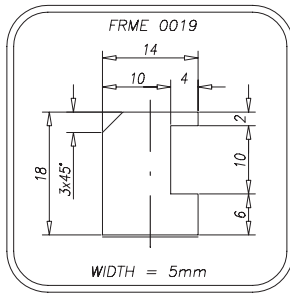

CLEATS

If the needed cleat wouldn't yet present in the following tables, please contact MEGADYNE staff.

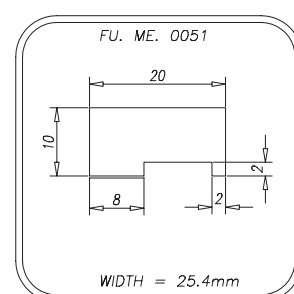
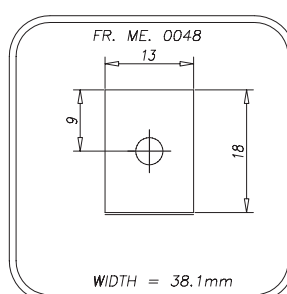
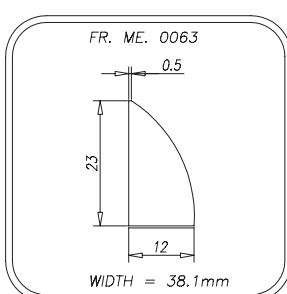
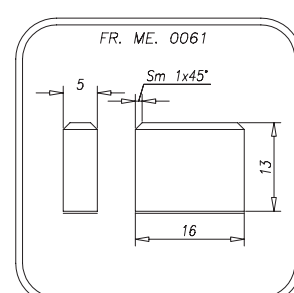
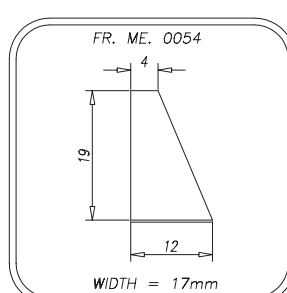
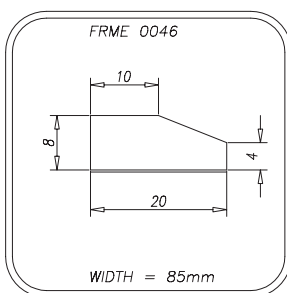
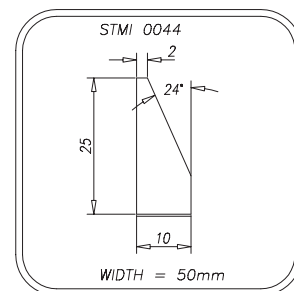
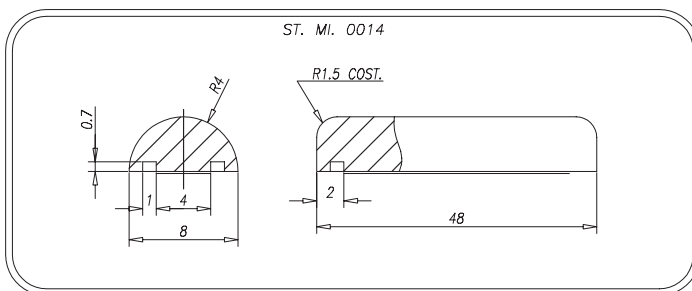
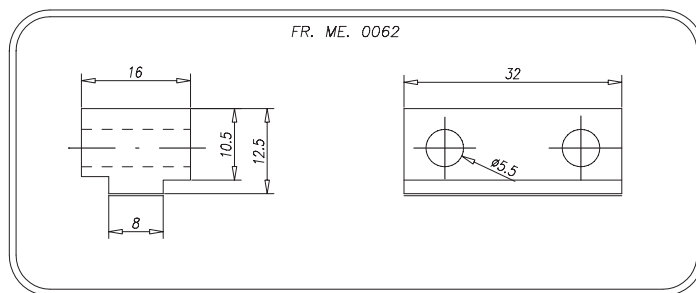
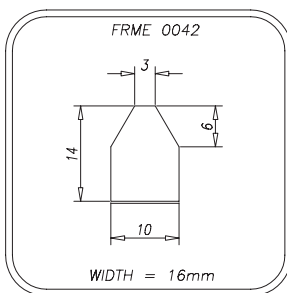
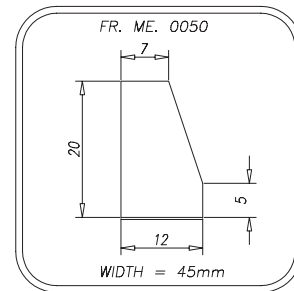
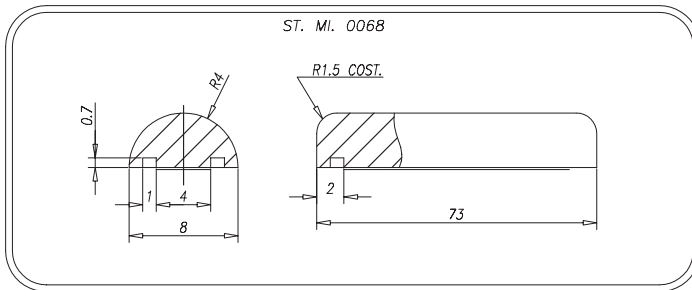

If the needed cleat wouldn't yet present in the following tables, please contact MEGADYNE staff.

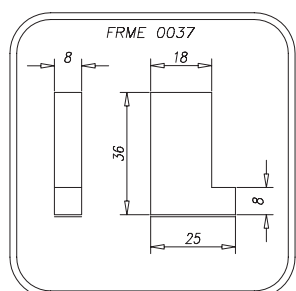
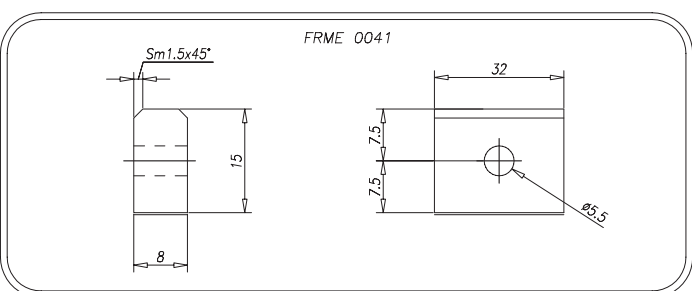
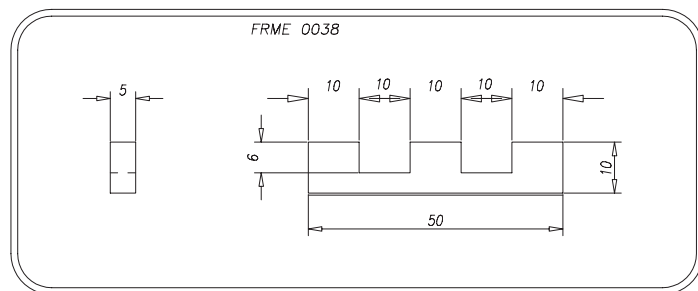
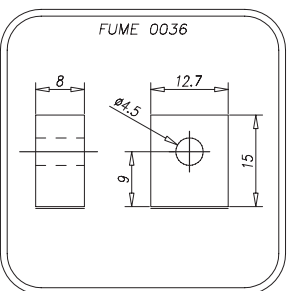
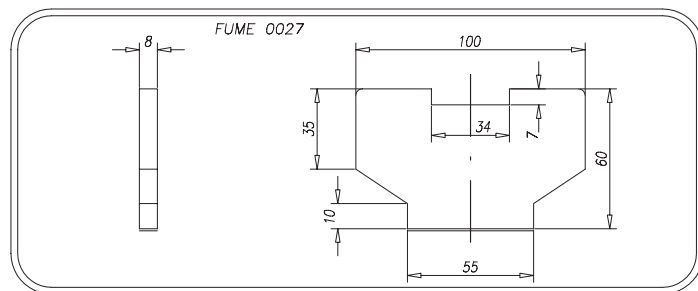
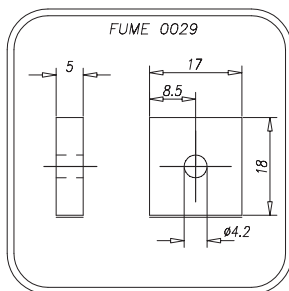
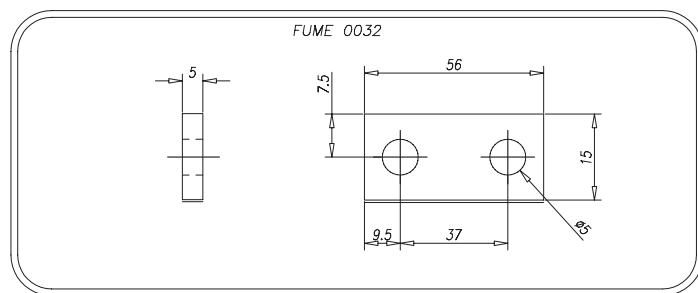
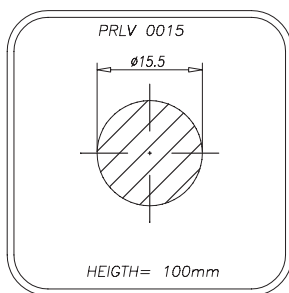
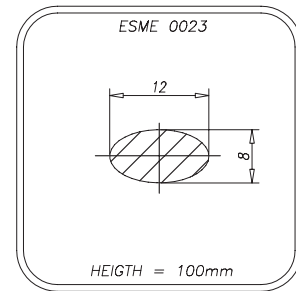
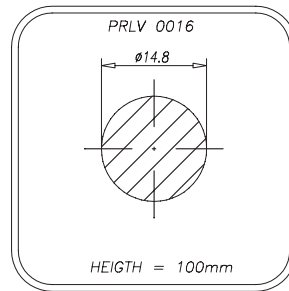
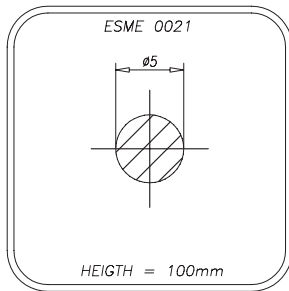

CLEATS

If the needed cleat wouldn't yet present in the following tables, please contact MEGADYNE staff.

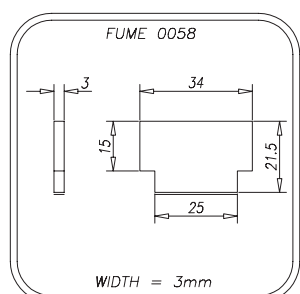
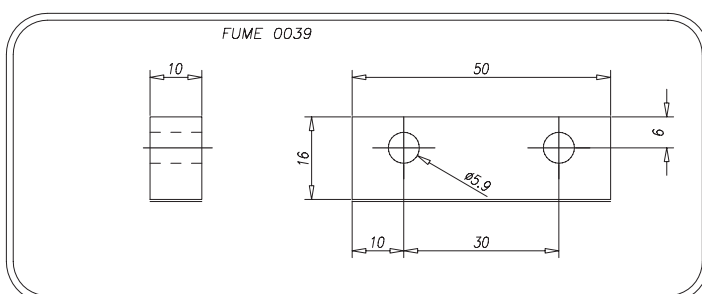
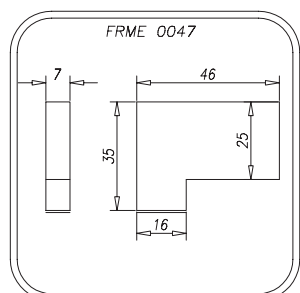
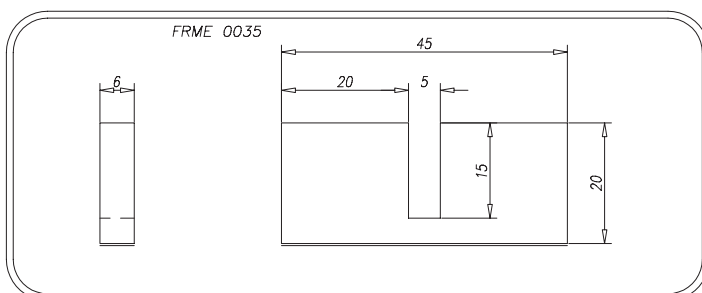
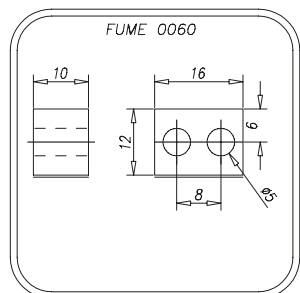
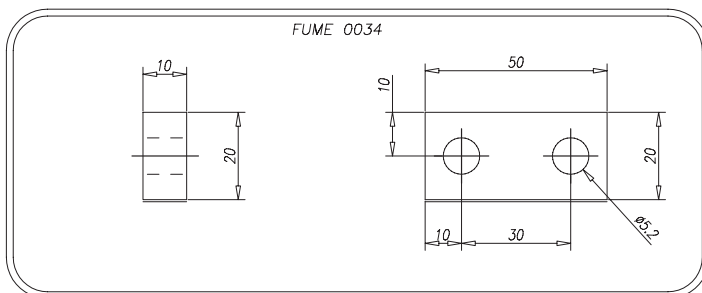
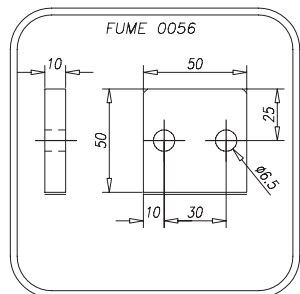
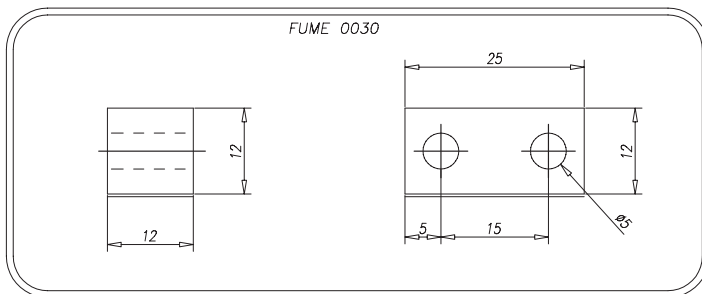
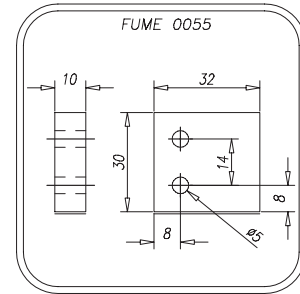
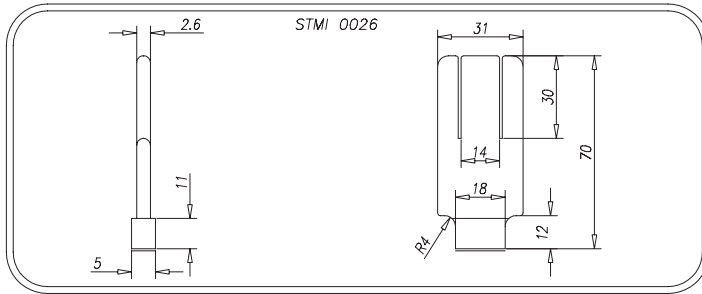

If the needed cleat wouldn't yet present in the following tables, please contact MEGADYNE staff.

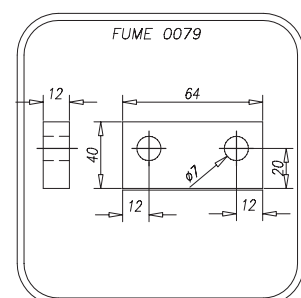
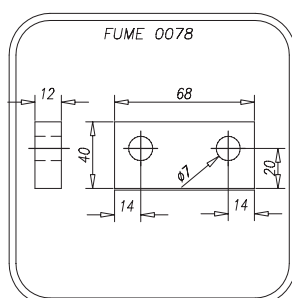
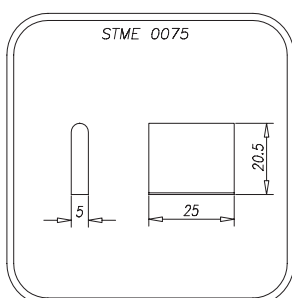
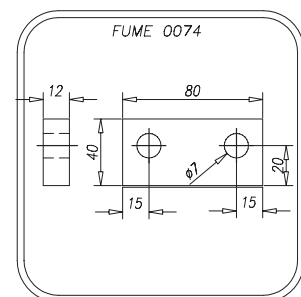
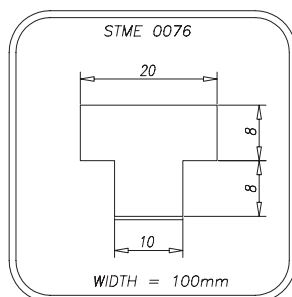
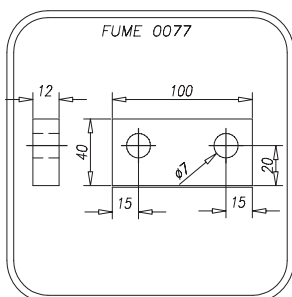
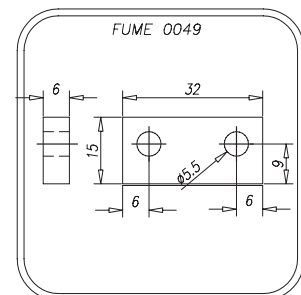
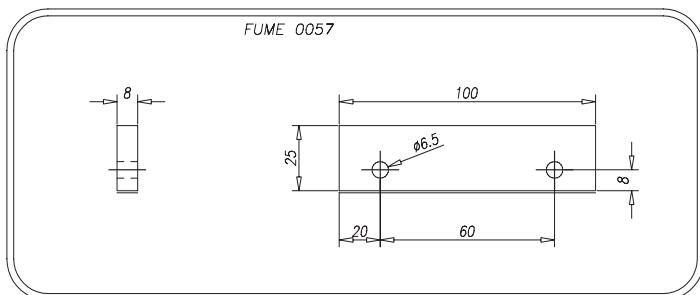
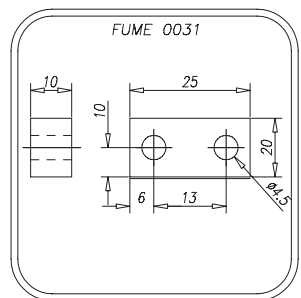
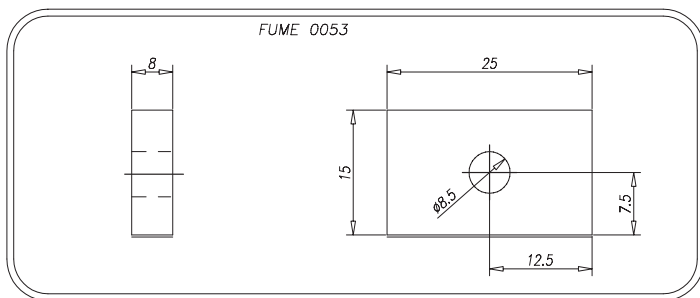
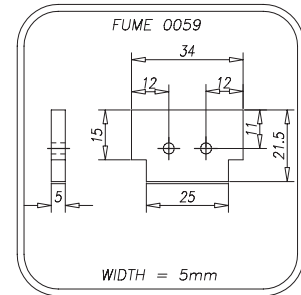
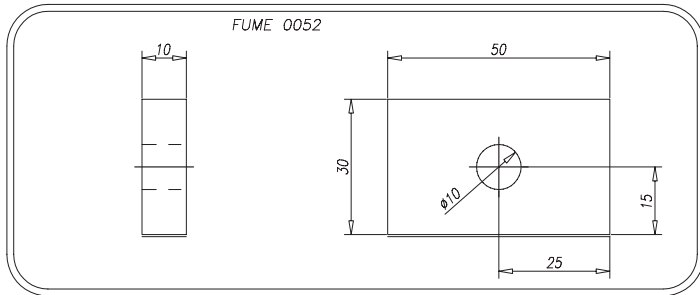

CLEATS

If the needed cleat wouldn't yet present in the following tables, please contact MEGADYNE staff.

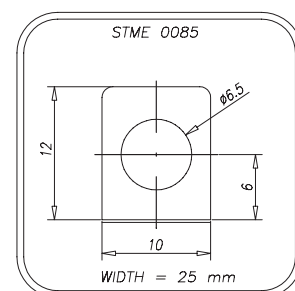
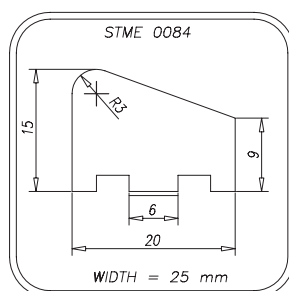
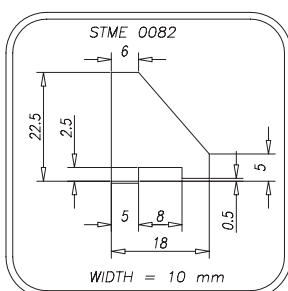
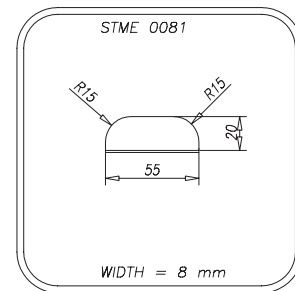
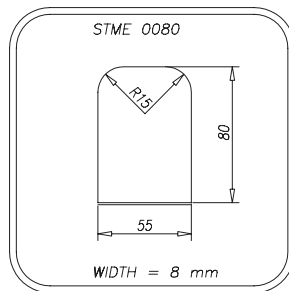
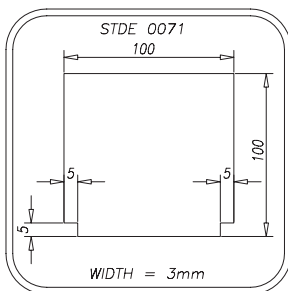
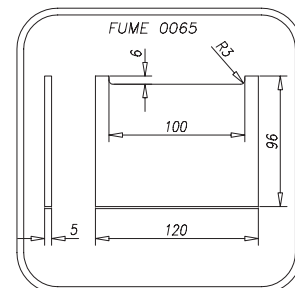
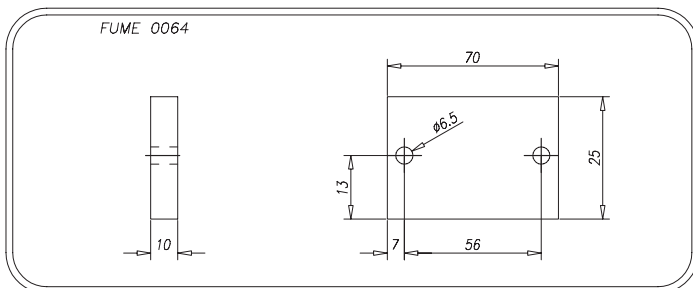
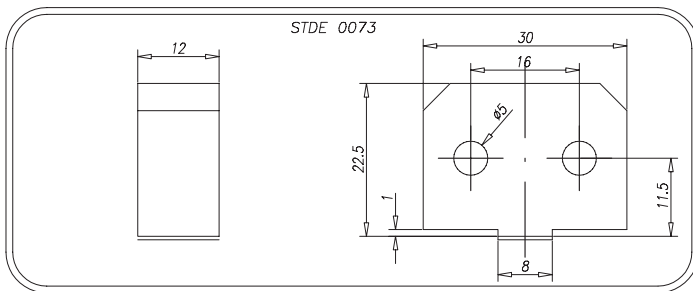
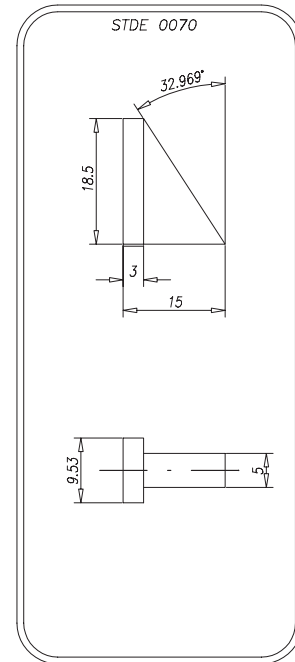
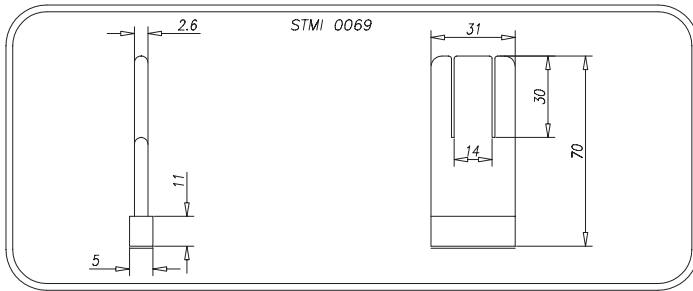

If the needed cleat wouldn't yet present in the following tables, please contact MEGADYNE staff.

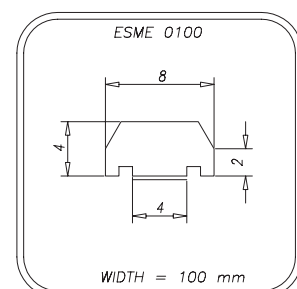
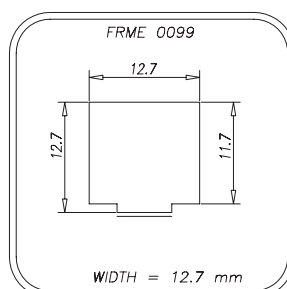
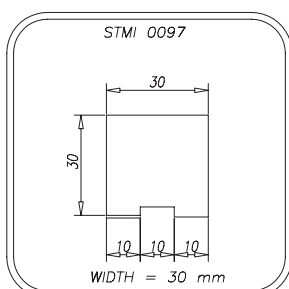
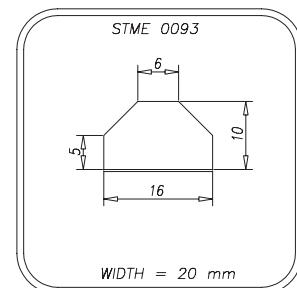
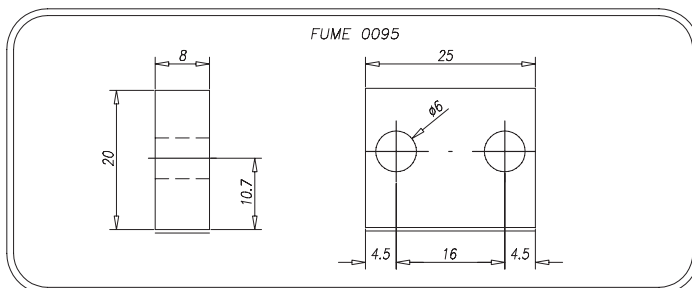
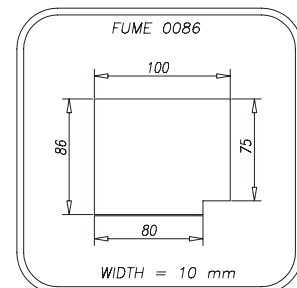
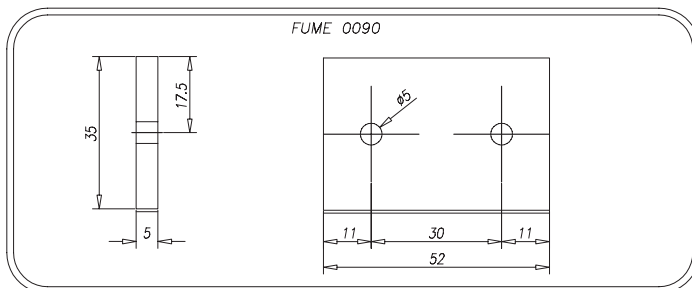
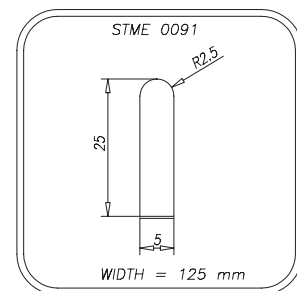
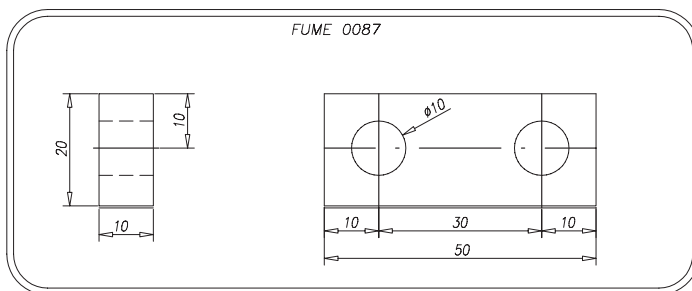
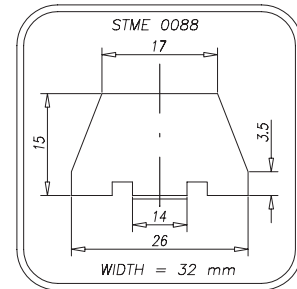
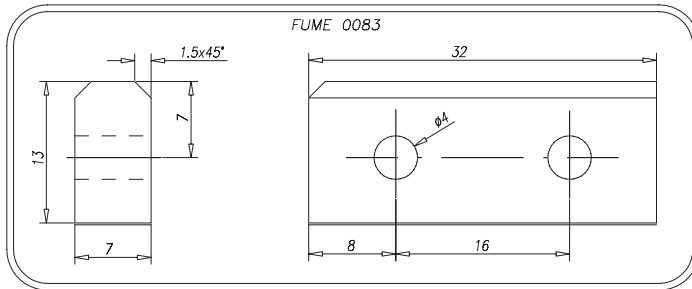

CLEATS

If the needed cleat wouldn't yet present in the following tables, please contact MEGADYNE staff.

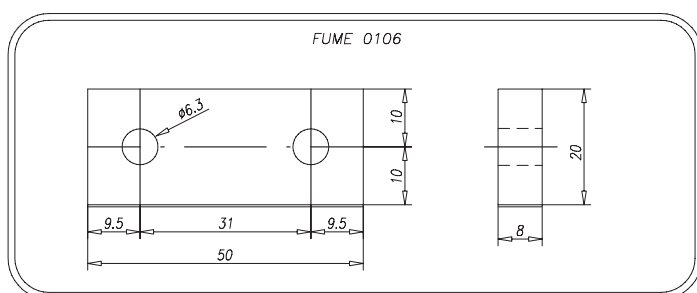
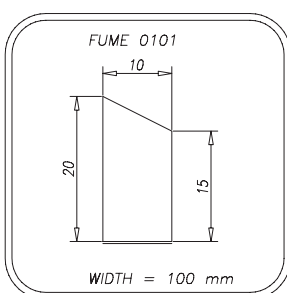
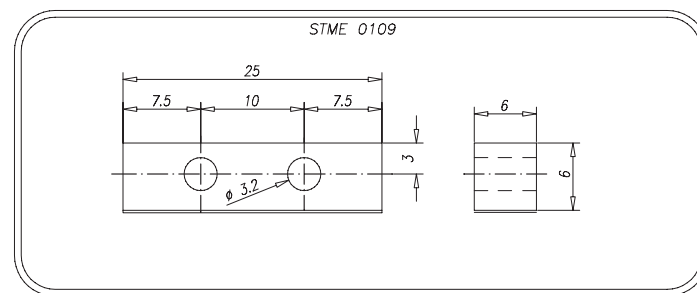
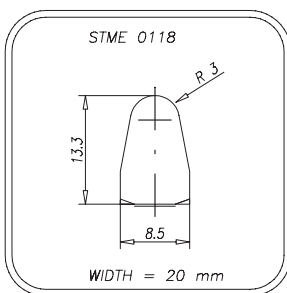
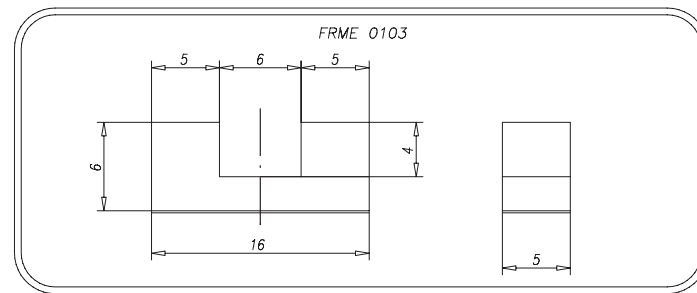
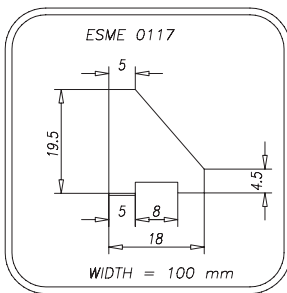
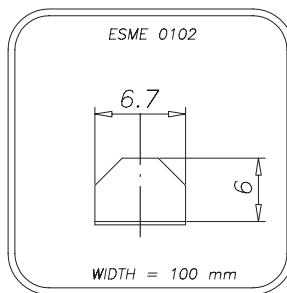
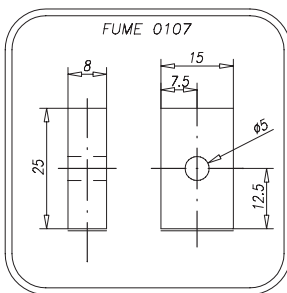
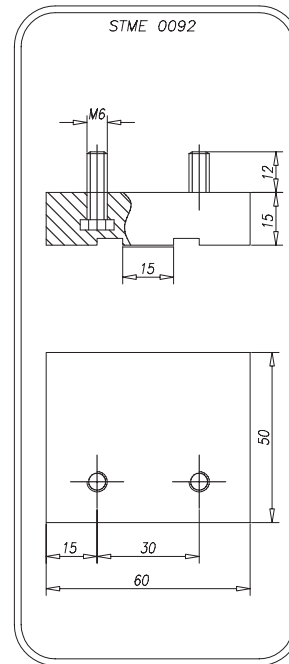
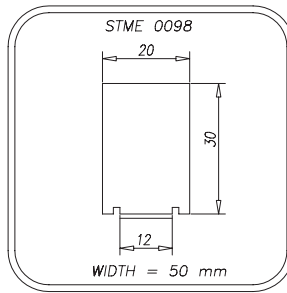
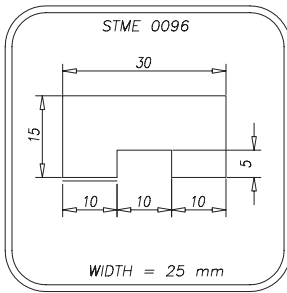

If the needed cleat wouldn't yet present in the following tables, please contact MEGADYNE staff.

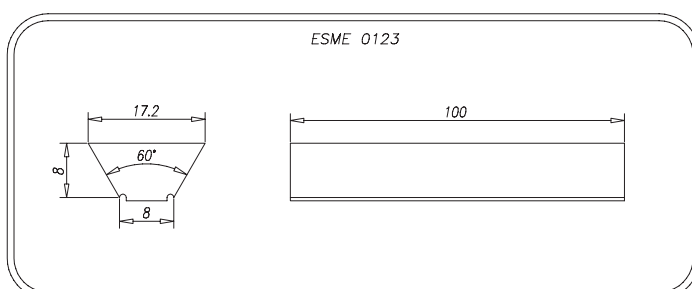
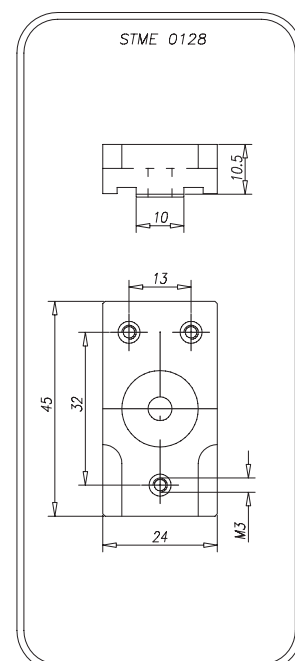
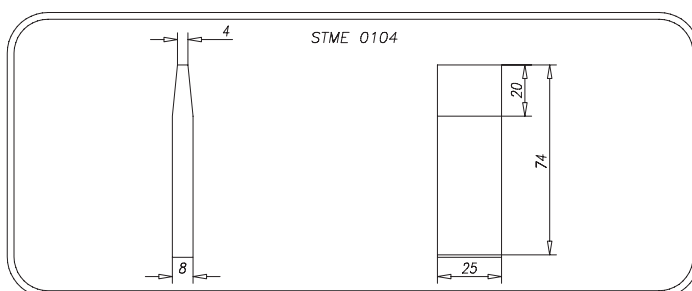
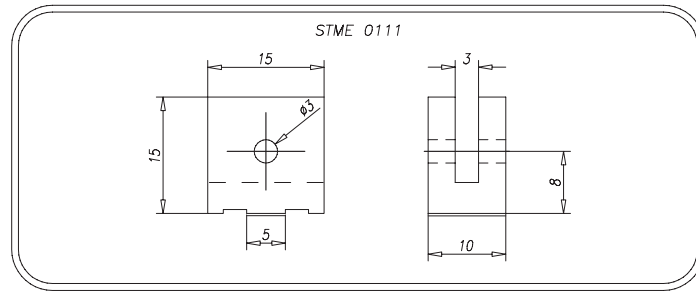
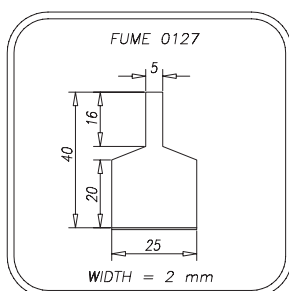
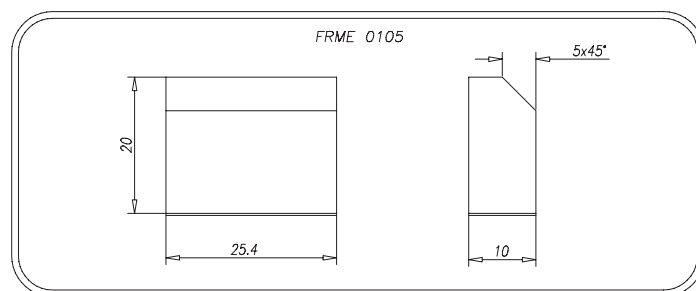
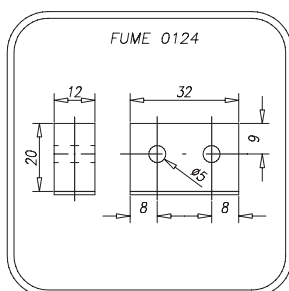
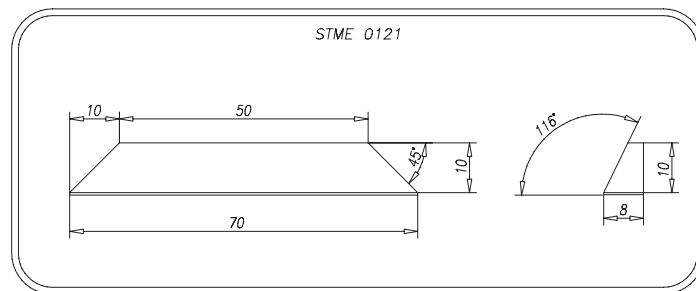
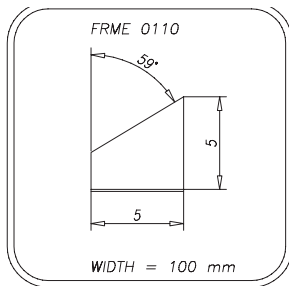

CLEATS

If the needed cleat wouldn't yet present in the following tables, please contact MEGADYNE staff.

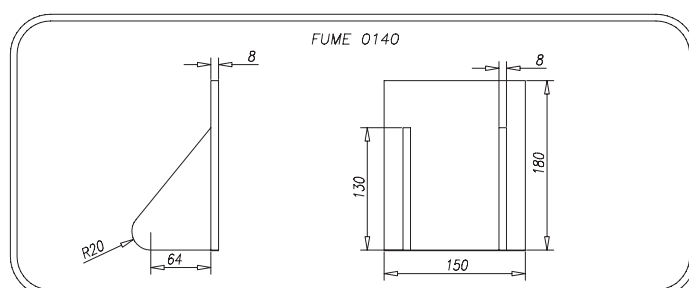
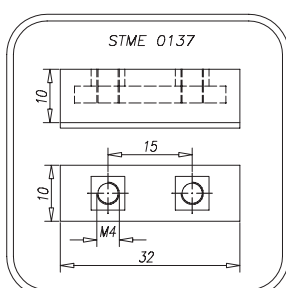
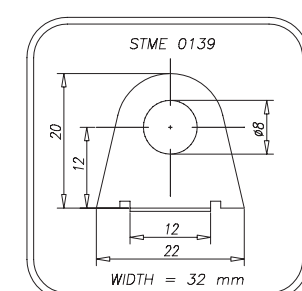
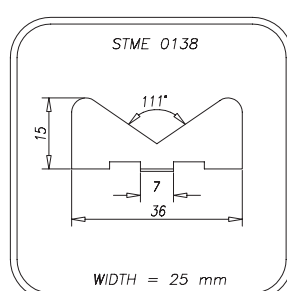
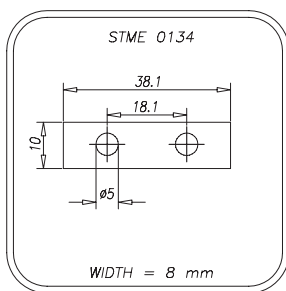
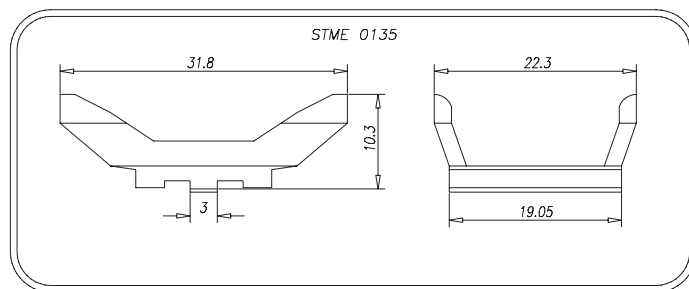
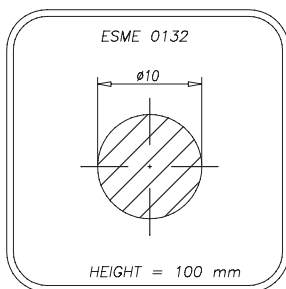
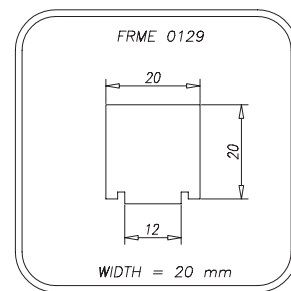
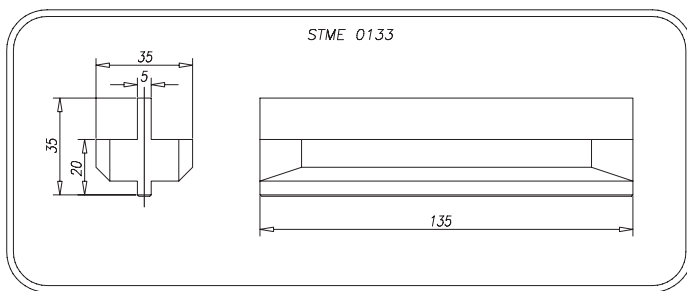
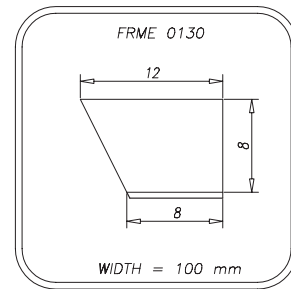
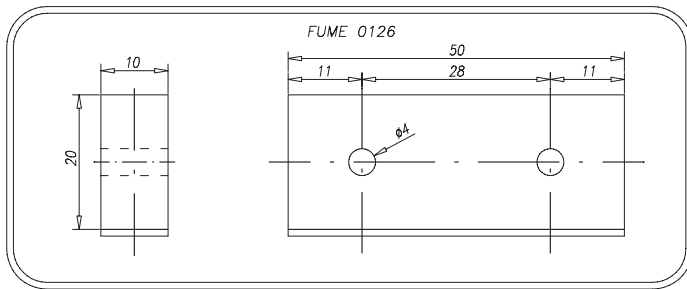

If the needed cleat wouldn't yet present in the following tables, please contact MEGADYNE staff.

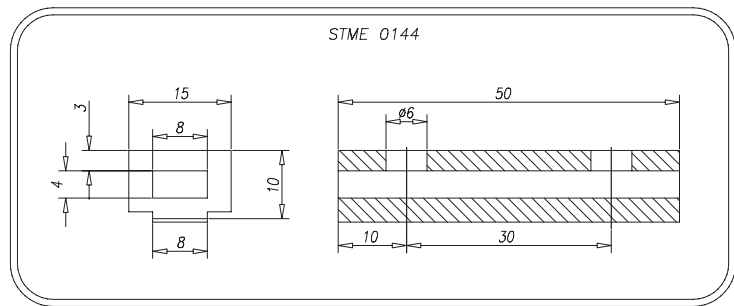
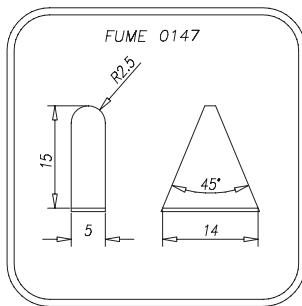
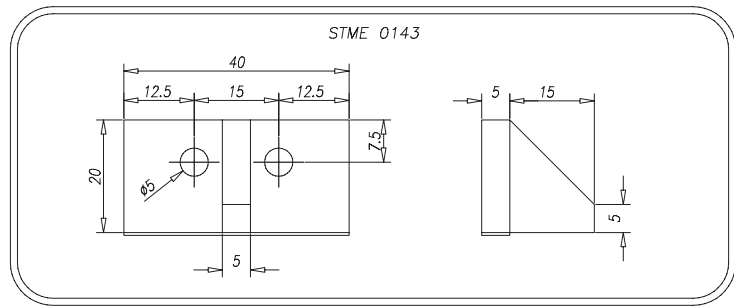
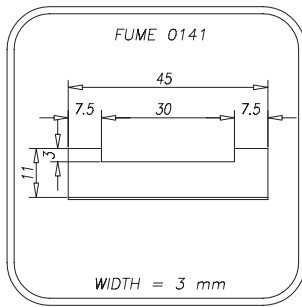

COVER PROPERTIES

Megalinear belt can be coated with several materials. Those coatings are able to suit Megalinear belts to all applications. Main advantages for using coated belts are: reducing noise and modifying friction in conveying materials. Choice of correct coating depends on application field.

Megadyne is able to supply extruded coated belt, in this case coating method is same as belt production method and cohesion between belt and cover is guaranteed by welding without using glue.

Properties of extruded coating are followings:

	Cover type								
	NFB nylon fabric back	NFT nylon fabric teeth	AVAFC 60	AVAFC 70	AVAFC 85	Foamed polyurethane	APL	Fishbone	Ribbed
Raw material	nylon	nylon	polyurethane	polyurethane	polyurethane	foamed polyurethane	polyurethane/PVC	polyurethane	polyurethane
Hardness (ShA)	–	–	60	70	85	50	55	70	70
Colour	green	green	transparent	transparent	transparent	yellow/grey	red	transparent	transparent
Coating and belt cohesion method	by extrusion	by extrusion	by extrusion	by extrusion	by extrusion	by spray	by extrusion	by extrusion	by extrusion
Thickness range (mm)	–	–	2/3/4	2/3/4	2/3/4	0,5 till 8	3,5	4,3	2,7
Tolerance on coating thickness	–	–	+/- 0,3	+/- 0,3	+/- 0,3	+/- 0,3	+/- 0,3	+/- 0,5	+/- 0,5
Working temperature range (°C)	-20 +80	-20 +80	-20 +80	-20 +80	-20 +80	-20 +60	-20 +60	-20 +80	-20 +80
Friction coefficient ⁽¹⁾	0,25	0,25	0,65	0,65	0,6	0,4	0,7	0,6	0,6
Water resistance	good	good	very good	very good	very good	good	good	very good	very good
Abrasion resistance	intermediate	intermediate	very good	very good	very good	very good	good	very good	very good
Oil resistance	intermediate	intermediate	good	good	good	very good	good	very good	very good
FDA approved	no	no	no	no	no	no	no	no	no
Min. pulley dia = thickness • ... ⁽²⁾	std pulley	std pulley	x 40	x 40	x 40	x 25	x 30	x 30	x 35



(1) Static Average values for steel guides

(2) Suggested diameter is bigger value between this calculated value and minimum pulley diameter on belt data page

Megalinear belt can be supplied also with vulcanised or glued cover. Their technical properties are listed in following table:

Cover type										
PVC Supergrip	Porol mousse	Linatex	Tenax 40	Tenax Standard	White Rubber for food industry	Neoprene	Gummy Correx ambrapablond	NBR	Hypalon	Honeycomb
PVC	open cell neoprene rubber	natural rubber	natural rubber	natural rubber	synthetic rubber	synthetic rubber	natural rubber	nitrilic rubber	rubber	natural rubber
55	10	42	40	45	70	70	48	70	60	50
green	black	red	red	red	white	gray/black	light/brown	white	white	red
by extrusion	by gluing	by gluing	by vulcanization	by vulcanization	by vulcanization	by vulcanization	by vulcanization	by vulcanization	by vulcanization	by gluing
4,5	2 till 15	0,8 till 15	0,8 till 15	0,8 till 15	0,8 till 15	0,8 till 15	0,8 till 15	0,8 till 15	0,8 till 15	4,5 till 15
+/- 0,5	+/- 0,3	+/- 0,3	+/- 0,3	+/- 0,3	+/- 0,3	+/- 0,3	+/- 0,3	+/- 0,3	+/- 0,3	+/- 0,5
-20 +60	-10 +60	-20 +50	-20 +60	-20 +60	0 +120	-10 +100	-20 +60	0 +120	0 +160	-20 +60
0,6	0,7	0,75	0,75	0,7	0,65	0,6	0,6	0,6	0,6	0,6
good	good	very good	very good	very good	good	very good	very good	good	good	very good
good	intermediate	very good	very good	very good	intermediate	good	very good	intermediate	intermediate	very good
good	intermediate	low	low	low	good	good	low	good	good	low
no	no	no	no	no	no	no	no	no	no	no
x 30	x 25	x 30	x 30	x 30	x 35	x 35	x 30	x 35	x 35	x 30



SPECIAL EXECUTION FEASIBILITY

Megadyne can make special extrusion on customer request to improve belt properties and to suit better to special applications.

SPECIAL POLYURETHANE

On customer request and with minimum quantity, Megalinear belt can be produced with different hardness:

- 85 ShA food quality polyurethane for contact with food and medical products
- 92 ShA higher resistance to temperature
- 92 ShA silicon free for painting system based on water
- 95 ShA glass reinforced
- 98 ShA extra hard polyurethane

COLOUR

On customer request and with a minimum quantity is possible to produce megalinear with several colours.

Different colour doesn't influence belt technical properties so mechanical features are same as standard white belt.

Available colours are: • White • Black • Blue • Yellow • Transparent

SPECIAL EXTRUSION

On customer request, Megadyne R&D department can develop special extruded belts by designing special mould.

It is also possible to extrude standard belt with special cords position, ready for successive reworkings.

MECHANICAL REWORK

Megadyne have been producing specialized belting for many years. Our in-house facilities enable us to produce belt with special holes for vacuum conveyors, belts with special backings / ground finishes for high tolerance applications. We can remove individual teeth and perforate the timing belt as required.

BACK GRINDING

A belt back can be ground to achieve a precise belt thickness as an adjunct to precision drives. When belt back grinding to a tolerance is required, the total thickness, including the tooth, must be specified. A grinding tolerance of ± 0.2 mm is achievable with a level finish (i.e. thickness will not vary greatly around the belt). Most widths and lengths are available.

LONGITUDINAL REWORK

Longitudinal rework along the belt back is possible on covered and uncovered belts. The profile can be machined precisely for required function. The measurement is given as the depth on the belt back. Most widths and lengths are available.

REWORK ON BELT TEETH

The rework of the tooth profile can be very useful, i.e. improving the steering effect with guide rails. The rework dimension is given from the top of the tooth. Most belt widths and lengths are available.

HOLES IN TIMING BELTS

Holes in timing belts can be for vacuum or air film conveying or as clearance for assembly mechanisms. Stops and cams can be attached through the holes. Customized tooling may be required depending on the layout and dimensions of holes required.

SINGLE TOOTH REMOVAL

Single and multiple tooth removal is available to your requirement, for applications in handling and conveying technology.

CERTIFIED BELTS FOR DIRECT FOOD CONTACT (MEGALINEAR FCM)

On customer request and with minimum quantity, it is possible to produce Megalinear belts

approved and certified for direct contact with dry and wet food according to EC 10/2011 and EC 1934/2004 regulations, and limited to the following configuration:

- 92 \pm 4 ShA special grade polyurethane, sky blue colour (RAL 5012 reference)
- Stainless steel cord insert only
- NFT\NFB fabric and covers options NOT available
- Available profiles T5-T10-T20-AT5-AT10-AT20-H-STD8-ATG10

ANTISTATIC POLYURETHANE TIMING BELTS

Megadyne now offers antistatic belts. Under certain conditions, a polyurethane belt may build-up a significant static electric charge. For applications where belts are intended for operation in a potentially explosive atmosphere or near electrical components, polyurethane belts should be sufficiently conductive to dissipate this electrical charge. Belts can be constructed (using proper nylon fabric coating) with a relatively low electrical resistance characteristic and are typically referred to as “static conductive” surface or “antistatic” surface. The test methods for determining the surface resistive properties of a belt are based on ISO 9563, “Belt Drives - Electrical Conductivity of Anti-static Endless Synchronous Belts - Characteristics and Test Method”. To be antistatic the electrical resistance, in ohms, of a belt measured in accordance with test method of norm ISO 9563, should not exceed:

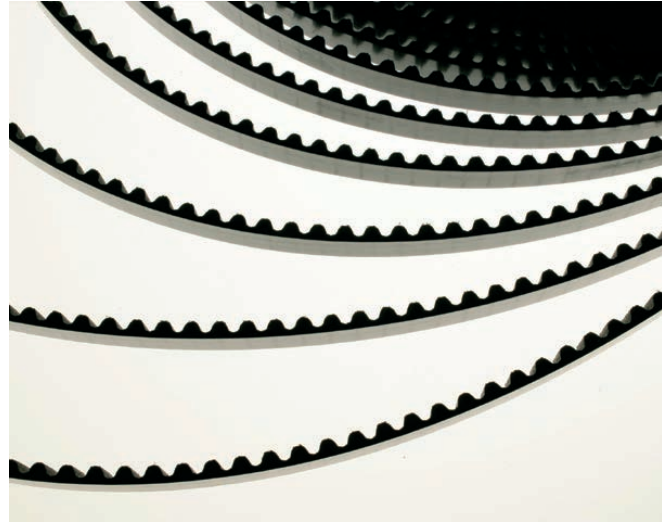

$$\text{Resistance} = \Omega = \frac{(6 \cdot 10^5) \cdot L}{W}$$

where: L = is dry distance between electrodes (7 grooves, 6 teeth between contacts)
W = is the width of the belt

L and W are expressed in the same units (mm or inches).

Megadyne antistatic belts are produced with black polyurethane as standard.

TYPICAL APPLICATIONS

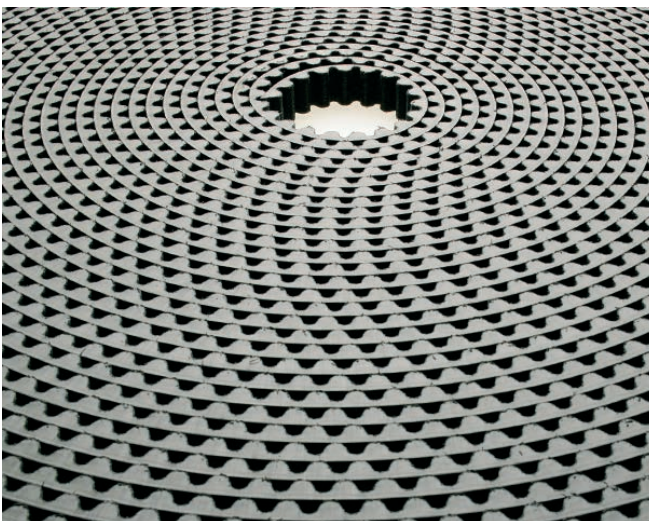

- Conveyance of PC boards or other electronic assemblies
- Semiconductor processing
- Conveying munitions of explosive detonators
- Paper conveying
- Power transmission applications in textile industries
- Chemical environment power transmission or conveying
- Clean room conveyors and power transmissions

SPECIAL EXECUTION PHOTOS

Glass Industry

Coating and special grinding on the back allow Megadyne belt to be suitable to all customer applications

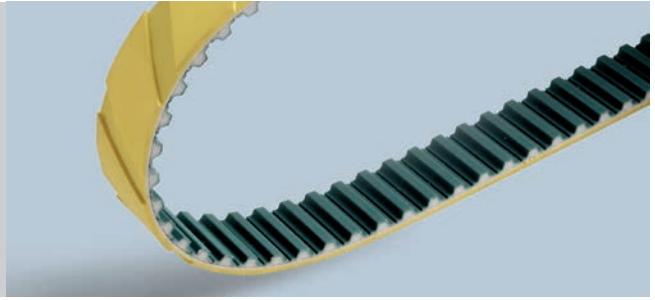

Tobacco industry

Belt with special cleats for tobacco industry



Nappy industry

Wide extruded belt for nappy industry

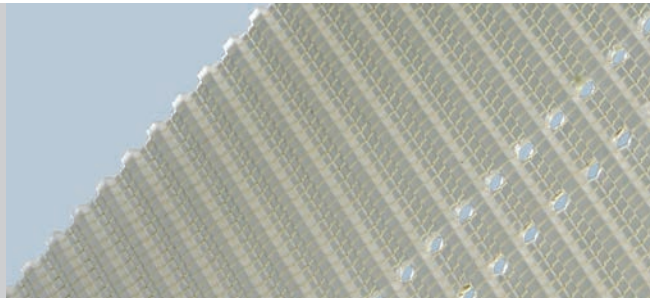

Packaging industry

Special reworking to install custom made elements

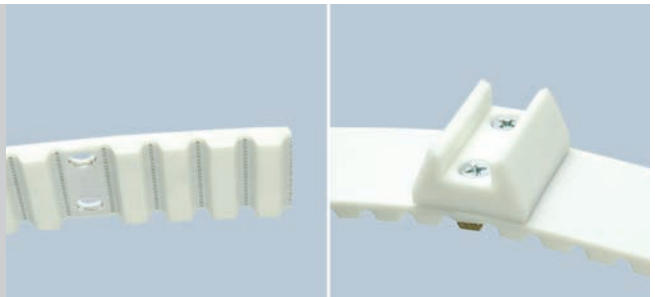

Automotive industry

Belt suitable to convey steel coils and plates due to guides on the back



Paper industry

Special extruded belt for vacuum conveyor application in paper industry



Carton Industry

New extruded belt
for vacuum application
in carton conveyor industry



Conveyor application

Special coating for conveyor application



Automotive industry

Due to its antistatic properties,
belt suitable for steel plate conveyor
in car industry

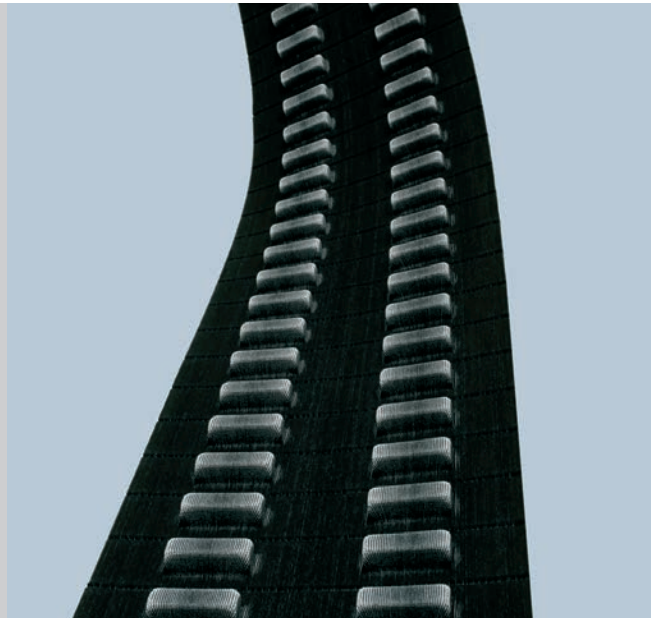

Lift industry

Patented belt
designed on customer requirement
for an innovative lift system

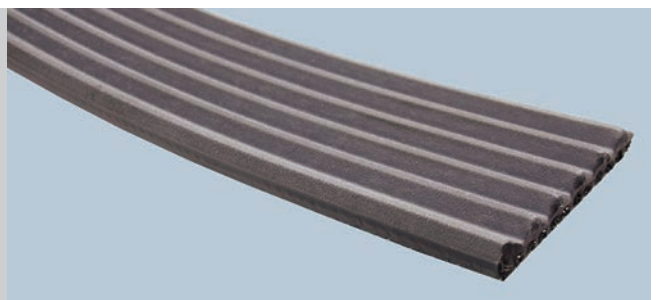

Fish industry

High variety of cleats allow
Megalinear belts to work
in several fields

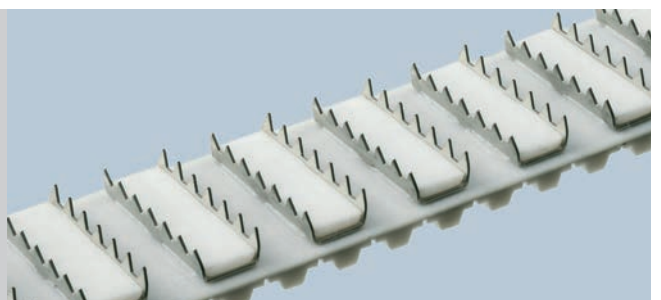

DATA SHEET

CUSTOMER DATA

Date ____/____/____

Company Name _____
 Address _____ Zip Code _____
 City _____ State _____ Country _____
 Customer Name/Surname _____
 Office _____ Tel. _____ Fax _____
 e-mail _____

DRIVE INFORMATION TRANSMISSION LAYOUT

Conveyor

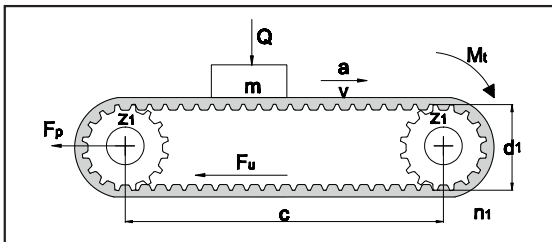

Linear motion (choose between the layout below)

Other (if layout is different please sketch it below)

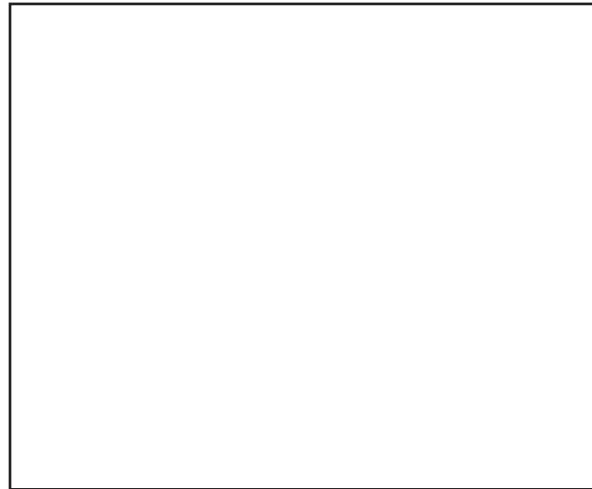
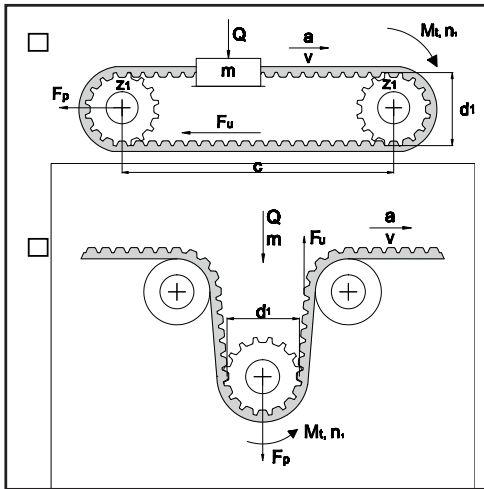

DRIVE INFORMATION (FOR CONVEYOR)

APPLICATION:

Driver pulley 's diameter: _____
 Driven pulley's diameter: _____
 Center distance: _____
 Minimum safety factor needed: _____
 Are there any size limitation? Yes No
 (if yes please indicate):
 Max diameter: _____
 Max width: _____
 Max center distance: _____
 Linear speed: _____
 Acceleration: _____
 Mass: _____

Is there any sliding surface? Yes No
 (if yes please indicate friction coefficient):

Is there any cover on the back? Yes No
 (if yes please indicate the type)

Are cleats required? Yes No
 (if yes please indicate cleats code, otherwise attach drawings)

Working time: < 8h From 8h up to 16h 24h

DATA SHEET

CUSTOMER DATA

Date ____/____/____

Company Name _____
 Address _____ Zip Code _____
 City _____ State _____ Country _____
 Customer Name/Surname _____
 Office _____ Tel. _____ Fax _____
 e-mail _____

DRIVE INFORMATION TRANSMISSION LAYOUT

Conveyor

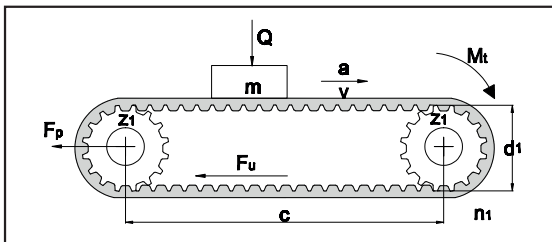

Linear motion (choose between the layout below)

Other (If layout is different please sketch it below)

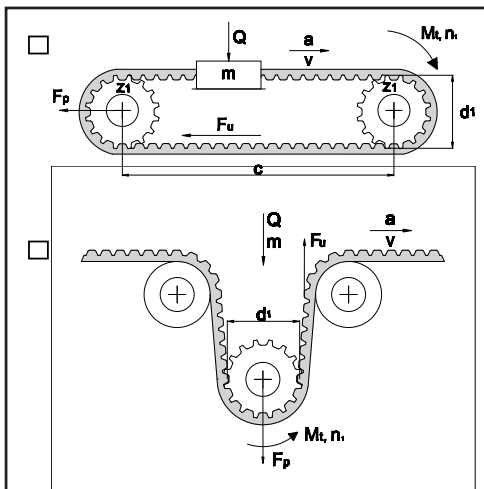

DRIVE INFORMATION (FOR CONVEYOR)

APPLICATION:

Driver pulley 's diameter: _____
 Driven pulley's diameter: _____
 Center distance: _____
 Minimum safety factor needed: _____
 Are there any size limitation? Yes No
 (if yes please indicate):
 Max diameter: _____
 Max width: _____
 Max center distance: _____
 Linear speed: _____
 Acceleration: _____
 Mass: _____

Is there any sliding surface? Yes No
 (if yes please indicate friction coefficient):

Is there any cover on the back? Yes No
 (if yes please indicate the type)

Are cleats required? Yes No
 (if yes please indicate cleats code, otherwise attach drawings)

Working time: < 8h From 8h up to 16h 24h

The data and information contained in the present catalogue are up-to-dated to the date of the catalogue's printing. Megadyne Spa reserves the right to modify the specifications, performances and other information relating to the belts described in the present catalogue, at any time at its own discretion, without any prior notice. For updating refer to our web site www.megadynegroup.com.

Technical specifications, performances and other information provided in the present catalogue are indicative and do not bound Megadyne unless such specifications, performances or other information are expressly agreed in the agreement with the customer.

We also recommend to read carefully the following documents in our web site www.megadynegroup.com:

- Megadyne General Conditions of Sale (comprising the warranty)
- Theoretical Belt Life
- Drive Components: Storage, Installation, Maintenance and Troubleshooting Handbook
- Belts standard use condition and temperature.

Copyright Notice: Megadyne Spa copyright. All rights reserved. Megadyne is and shall remain the owner of all rights on drawings, technical specifications and any other information contained in the present catalogue or otherwise communicated by Megadyne Spa to the customer. The customer shall not disclose such information to third parties or use such information for purposes different from the definition of the order to Megadyne Spa, unless upon prior written authorization of Megadyne.



Megadyne S.p.A.
Italy - MATHI

BELARUS
Minsk
Phone +375 17 2802486
Info.by@megadynegroup.com

BRASIL
Sorocaba
Phone +55 15 2101 7700
Info.br@megadynegroup.com

CANADA
Edmonton
Phone: +1 780 461 4400
Info.ca@megadynegroup.com

Montreal
Phone: +1 514 31 2341
Info.ca@megadynegroup.com

Toronto
Phone: +1 905 602 4400
Info.ca@megadynegroup.com

CHINA
Beijing
Phone +86 10 8150 7478
info.cn@megadynegroup.com

Foshan
Phone +86 757 8381 5530
info.cn@megadynegroup.com

Ningbo*
Phone +86 574 8650 5008
info.cn@megadynegroup.com

Qingdao*
Phone +86 532 8658 0951
info.cn@megadynegroup.com

Shanghai
Phone +86 21 5447 1473
info.cn@megadynegroup.com

Xi'an
Phone +86 29 86358108
info.cn@megadynegroup.com

COLOMBIA
Bogotá
Phone: + 57 (1) 471 0503
Info.co@megadynegroup.com

Cartagena
Phone: + 57 (5) 672 997
Info.co@megadynegroup.com

CZECH REPUBLIC
Prague
Phone +420 2 8481 7181
Info.cz@megadynegroup.com

FRANCE
Paris
Phone +33 1 6079 8200
info.fr@megadynegroup.com

St. Jean De Maurienne*
info.fr@megadynegroup.com

GERMANY
Borchen
Phone +49 5251 8735 0
info.de@megadynegroup.com

Elchingen*
info.de@megadynegroup.com

HUNGARY
Budapest
Phone +36 23 428 628
info.hu@megadynegroup.com

INDIA
Chennai*
Phone +91 98841 81175
info.in@megadynegroup.com

ISRAEL
Caesarea
Phone +972 4 6371485
sales@megabelt.co.il

ITALY
Turin*
Phone +39 011 926 8052
info@megadynegroup.com

Milan*
Phone +39 039 689 601
info.it@megadynegroup.com

Pescara
Phone +39 085 9700547
info.it@megadynegroup.com

Venice
Phone: +39 041 929 367
info.it@megadynegroup.com

MEXICO
Mexico C.P.
Phone +52 55 5587 3680
info.mx@megadynegroup.com

PERU
Lima
Phone + 51 713 0069
info.pe@megadynegroup.com

POLAND
Bydgoszcz*
Phone +48 52 348 77 12
info.pl@megadynegroup.com

SOUTH AFRICA
Johannesburg
Phone +27 (0)12 661 1652
info.za@megadynegroup.com

Cape Town
Phone +27 (0)21 9820772
info.za@megadynegroup.com

SPAIN
Barcelona*
Phone + 34 933 774 441
www.avetm.com

Vilanova*
Phone +34 93 811 5450
info.es@megadynegroup.com

SWEDEN
Kristianstad
Phone +46 10 1309600
info.se@megadynegroup.com

THAILAND
Bangkok
Phone: +66 966 207648
info.th@megadynegroup.com

TURKEY
Izmir*
Phone +90 232 877 07 00
info.tr@megadynegroup.com

U.K.
Birmingham
Phone: +44 1384 215 021
info.uk@megadynegroup.com

U.S.A
California
Phone +1 323 265 8061
info.us@megadynegroup.com

Florida
Phone +1 813 241 4111
info.us@megadynegroup.com

Georgia*
info.us@megadynegroup.com

Illinois
Phone: +1630 752 0600
info.us@megadynegroup.com

New Jersey Americas HQ
Phone +1 973 227 4904
info.us@megadynegroup.com

New York*
Phone +1 716 667-7450
info.us@megadynegroup.com

North Carolina*
info.us@megadynegroup.com

Oregon
Phone +1 503 231 7224
info.us@megadynegroup.com

Texas
Phone +1 972 438 6992
info.us@megadynegroup.com

HEADQUARTERS

ITALY Turin
Via S. Lucia, 114
10075 Mathi (Torino)
Phone +39 011 926 8052
info@megadynegroup.com

www.megadynegroup.com



* Manufacturing locations